



CableIQ™

Qualification Tester

Getting Started Guide

PN 2113427

January 2005, Rev. 3 9/2018

© 2005, 2007, 2015, 2018 Fluke Corporation

All product names are trademarks of their respective companies.

LIMITED WARRANTY AND LIMITATION OF LIABILITY

Fluke Networks mainframe products will be free from defects in material and workmanship for one year from the date of purchase, unless stated otherwise herein. The CableIQ wiremap adapter is also warranted for one year. Parts, accessories, product repairs and services are warranted for 90 days, unless otherwise stated. Ni-Cad, Ni-MH and Li-Ion batteries, cables or other peripherals are all considered parts or accessories. This warranty does not cover damage from accident, neglect, misuse, alteration, contamination, or abnormal conditions of operation or handling. Resellers are not authorized to extend any other warranty on Fluke Networks' behalf. To obtain service during the warranty period, contact your nearest Fluke Networks authorized service center to obtain return authorization information, then send your defective product to that Service Center with a description of the problem.

For a list of authorized resellers, visit www.flukenetworks.com/wheretobuy.

THIS WARRANTY IS YOUR ONLY REMEDY. NO OTHER WARRANTIES, SUCH AS FITNESS FOR A PARTICULAR PURPOSE, ARE EXPRESSED OR IMPLIED. FLUKE NETWORKS IS NOT LIABLE FOR ANY SPECIAL, INDIRECT, INCIDENTAL OR CONSEQUENTIAL DAMAGES OR LOSSES, ARISING FROM ANY CAUSE OR THEORY. Since some states or countries do not allow the exclusion or limitation of an implied warranty or of incidental or consequential damages, this limitation of liability may not apply to you.

4/15-CIQ

Fluke Networks
PO Box 777
Everett, WA 98206-0777
USA

CableIQ™ Qualification Tester

Accessing the Users Manual

This guide provides basic information to help you quickly get started using the tester. The *CableIQ Qualification Tester Users Manual* on the Fluke Networks website provides additional information.

⚠ Safety

⚠ Warning ⚠

To avoid possible fire, electric shock, or personal injury:

- The tester is not intended to be connected to active telephone inputs, systems, or equipment, including ISDN devices. Exposure to the voltages applied by these interfaces may damage the tester and create a potential shock hazard. Disconnect the tester if the voltage alert symbol (⚡) appears.
- Read the safety information given in the Safety Information booklet before using the tester.

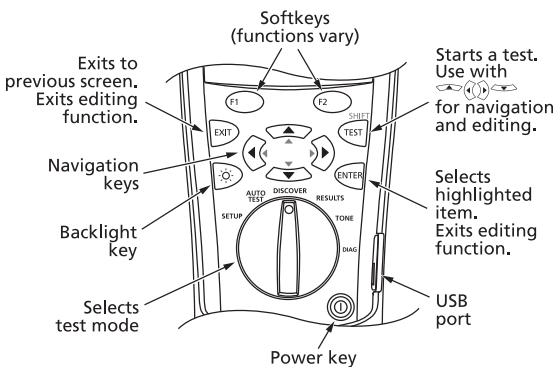

Controls



AXY01

CableIQ Getting Started Guide

Setting User Preferences



Turn the rotary switch to **SETUP**; then use   and  to select a setting.



- **User Information:** Three lines of text are stored with saved Autotests.
- **Language / ft·m:** Select a language for the display. Select feet or meters for length measurements.
- **Time / Date:** Timestamp saved Autotests.
- **Auto Shutoff:** The tester stays on indefinitely or turns off after 15 minutes of inactivity.

Editing Text

Use the keys to edit text on the **User Information** and **Enter ID** screens.

: Selects the highlighted field for editing.

 : Moves the cursor. Moving the cursor beyond the last character inserts the first character from the last character's set.

 : Changes the highlighted character.

 **Ins:** Inserts the first character from the set that includes the highlighted character.

 **Del:** Deletes the highlighted character.

SHIFT and  or **SHIFT** and : Changes the character set.

Character Sets Available

A B C D E F G H I J K L M N O P Q R S T U V W X Y Z

a b c d e f g h i j k l m n o p q r s t u v w x y z

0 1 2 3 4 5 6 7 8 9

! \$ % & ' () * + , - . / : ; < = > ? @ [\] ^ _ ` { | } space

Connecting for Cabling Tests

Notes

A wiremap adapter or remote ID locator must be connected to the end of the cabling for the wiremap to be completely verified.

If you use patch cords at the near or far end during an Autotest, Fluke Networks recommends patch cords at least 2 m long.

Connecting to a Data Link

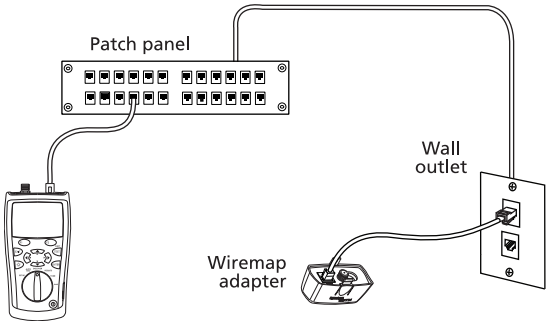

AXY10

Connecting to a Bus Topology

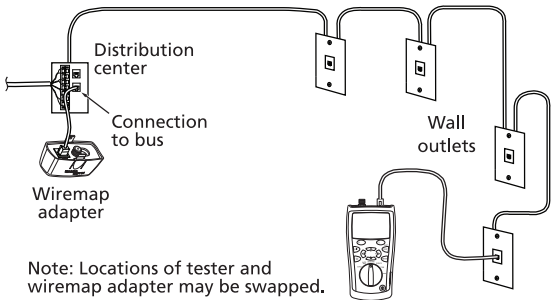

Note: Locations of tester and wiremap adapter may be swapped.

AXY13

CableIQ Getting Started Guide

Connecting to a Star Topology

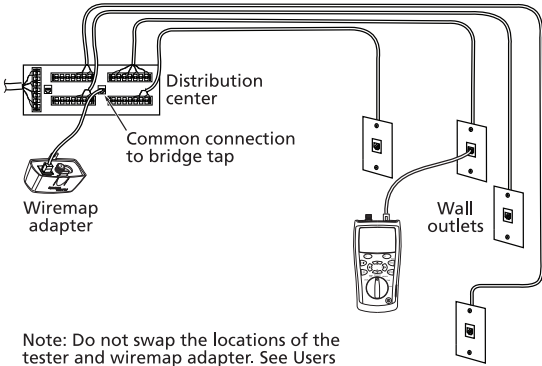

AXY12



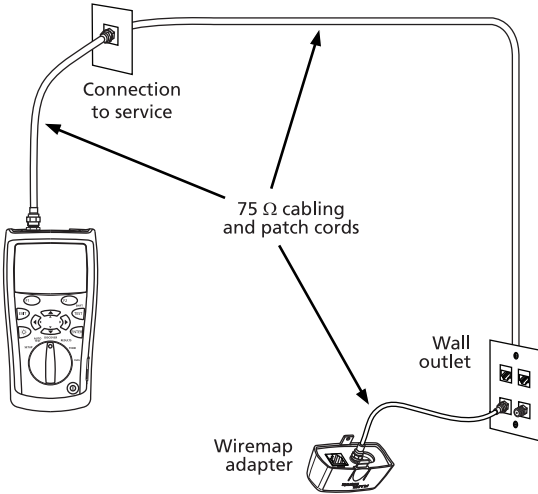









Connecting to Coaxial Cabling



AXY34

Results Icons

The icons below appear on Autotest and Discover screens.

	The cabling qualifies for the application.
	The cabling does not qualify for the application.
	Results are for informational purposes only, not for qualification. The cabling cannot be completely qualified for the application because the wiremap results are incomplete (wiremap adapter not used).
	Pair is open.
	Pair is shorted.
	Wiremap adapter or remote ID locator at far end, with its number.
	Bridge tap detected.
	Hub, switch, or PC NIC card detected. Port speeds are 10, 100, 1000 Mb/s.
	Voltage detected. This may indicate an active telephone circuit, ISDN line, or Power over Ethernet (PoE) device.
	The tester is connected to an active telephone circuit.
	A signal is present on the pair.
	The tester cannot identify the termination.

Discovering Cabling Characteristics

Discover mode lets you quickly check wiremaps, measure length, and determine if cabling is connected to a network port, video device, or telephone.

Turn the rotary switch to **DISCOVER**, then connect to twisted pair or 75 Ω coaxial cabling with or without a wiremap adapter at the far end. Results from Discover mode cannot be saved.

Discover Mode on Twisted Pair Cabling

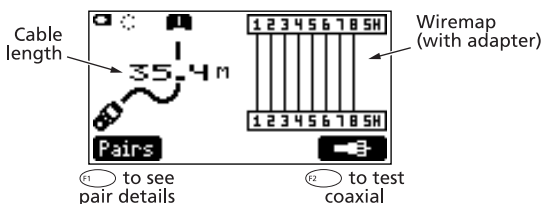

AXY46

Discover Mode on a Bridge Tap

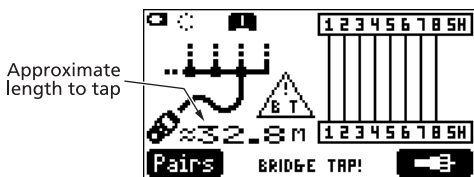

AXY49

Discover Mode on a Port

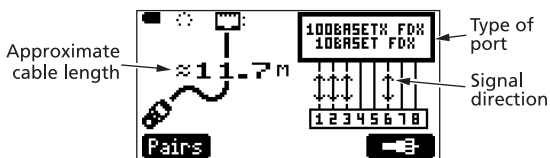

AXY48

Discover Mode on Coaxial Cabling with Adapter

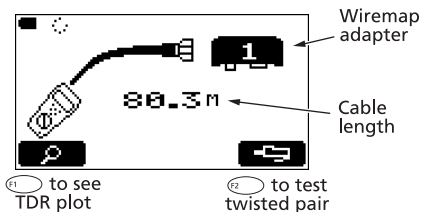

AXY50

Discover Mode on Coaxial Cabling Connected to a Device

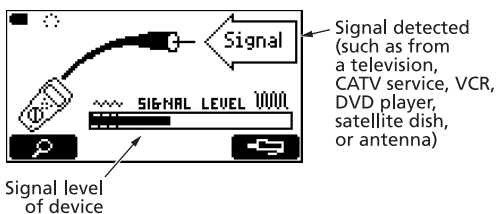

AXY35

CableIQ Getting Started Guide

Discover Mode with MultiMap

Verifies wiremaps of multiple telephone outlets connected in a star or bus topology.

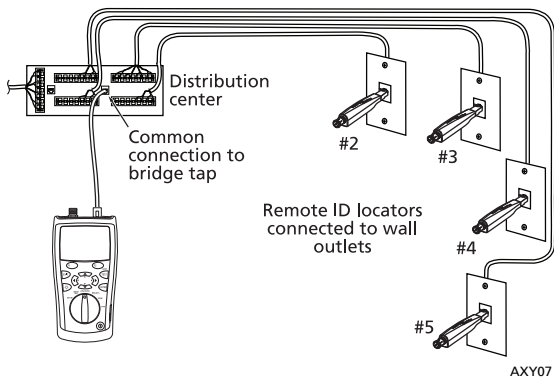

Qualifying Cabling with the Autotest

The Autotest tells you if cabling will support a selected application. You can save Autotest results to document an installation.

Connect to the cabling as shown on pages 3 and 4. Turn the rotary switch to **AUTOTEST**. To select tests and pairs to test, press **F1 Setup**. To start the test, press **TEST**.

Note

The Autotest does not support use of multiple remote ID locators (the MultiMap function).

To save the test, press **F2** **Save**. You can enter a **Site** name, **Location**, and **Outlet** to identify the results. The last character of the **Outlet** string increments each time you save an Autotest.

Autotest Results for Twisted Pair Cabling

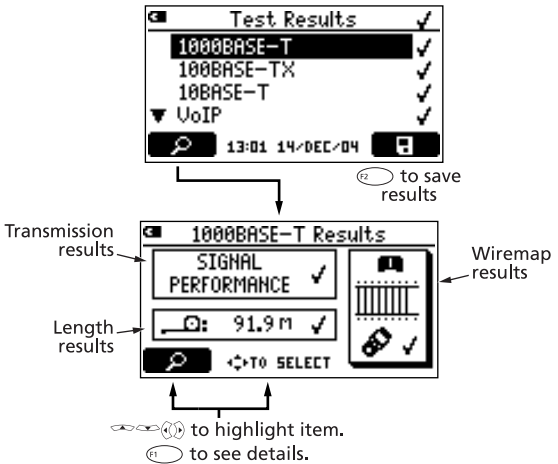

AXY14

Using the Toner

Turn the rotary switch to **TONE**; then select a tone function. The two IntelliTone™ functions work with a Fluke Networks IntelliTone probe. The other four analog tones can be detected by most tone probes.

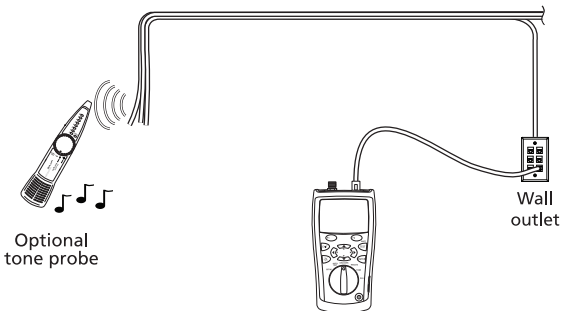

AXY06

Blinking a Port Light

The **Blink Port Light** function helps you determine which cable is connected to which port on a network hub or switch.

The tester's analog toner is also active when the port light function is active.

Turn the rotary switch to **DIAG**; then select **Blink Port Light**. Look for the blinking activity LED on the hub or switch.

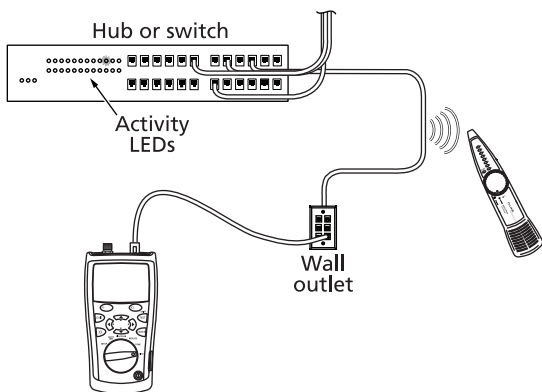

AXY05

Testing for Continuity

The continuity function lets you test for opens and shorts on the 8-pin modular jack or the coaxial connector.

Turn the rotary switch to **DIAG**. Use  to highlight **Continuity**; then press , , or .

The tester's beeper is silent for resistances above about 5000 Ω . The beeper's tone and rhythm increase as resistance decreases.

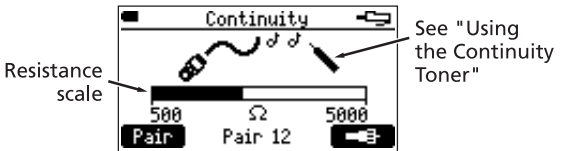
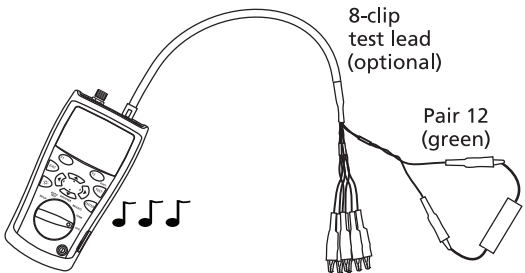

 to change pair used

 to test on coaxial connector

AXY37

Using the Continuity Toner

Turn the rotary switch to **DIAG**; then select **Continuity**. The beeper's tone and rhythm increase as resistance decrease.

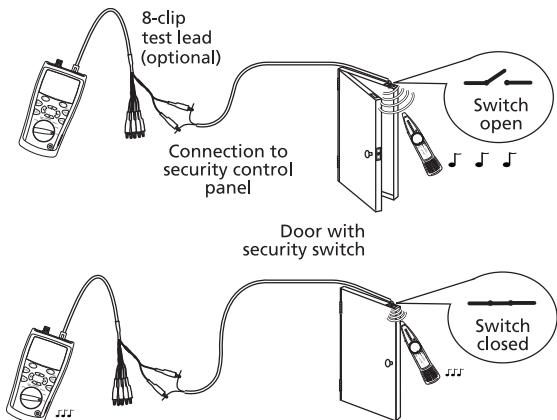

AXY38

Locating Crosstalk and Impedance Faults

The **Find Crosstalk Fault** and **Find Impedance Fault** functions let you quickly check cable pairs for crosstalk and impedance faults on twisted pair cabling.

Turn the rotary switch to **DIAG**, select **Find Crosstalk Fault** or **Find Impedance Fault**; then press **ENTER** or **F1**. Select a transmission standard and pair or pairs to test; then press **TEST**. A wiremap adapter or ID locator is not required.

Testing Speaker Cabling

The **Speaker Test** generates audible tones for testing the wiring and phase of installed twisted pair speaker cabling.

Turn the rotary switch to **Diag**; then select **Speaker Test**.

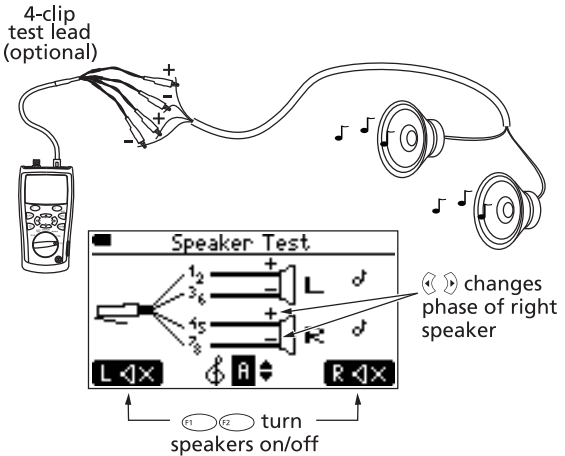

AXY39

4-clip test lead wiring:

+ Pair 12: green

+ Pair 45: blue

- Pair 36: orange

- Pair 78: brown

Replacing the Batteries

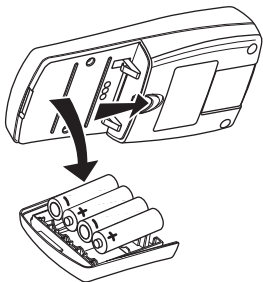

Remove the yellow boot to access battery door.

4 AA batteries
(alkaline recommended)
20 hours typical battery life.

AXY53

Contacting Fluke Networks



www.flukenetworks.com/support



info@flukenetworks.com



1-800-283-5853, +1-425-446-5500



Fluke Networks

**6920 Seaway Boulevard, MS 143F
Everett WA 98203 USA**

Fluke Networks operates in more than 50 countries worldwide. For more contact information, visit our website.