



Boeing B737-800 Maintenance Simulation

AT-S01



* Notebook is excluded

*The pictures above are for reference only.
The real products purchased should be considered as final.

Through 26 simulation modules, users are able to approach step by step training from Aircraft Walk Around to the internal cockpit control in every aspect of B737-800. Moreover the simulation content focus on the position introduction of every control panel and component parts in terms of the operation method and control theory. It is an ideal solution for beginners who intend to enter the world of aviation. Not only for training in school but also for self-studying.

The software includes Mechanical Engineering (ME) and Avionics (AV), the module contents are as followed:



1. Aircraft Walk Around



2. Aircraft General

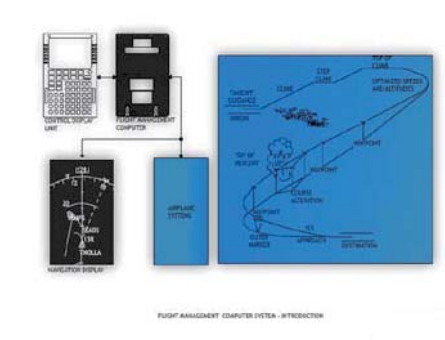

3. Flight Management Introduction



4. Flight Instruments



5. Flight Director

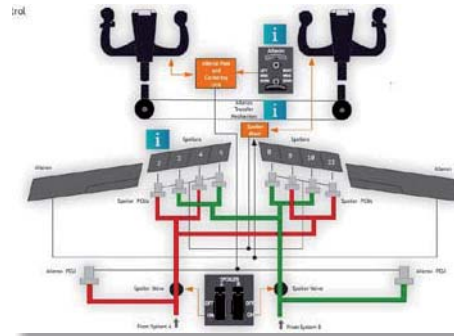

6. Flight Controls



7. AC Communications



8. Navigation



9. Autopilot



10. Auto Throttles

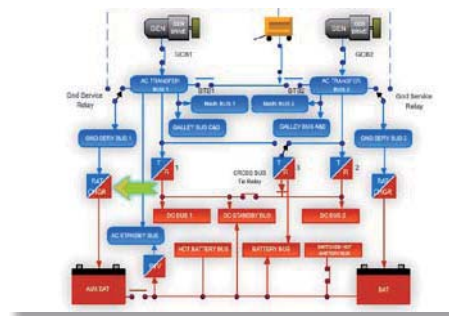

11. Electrical

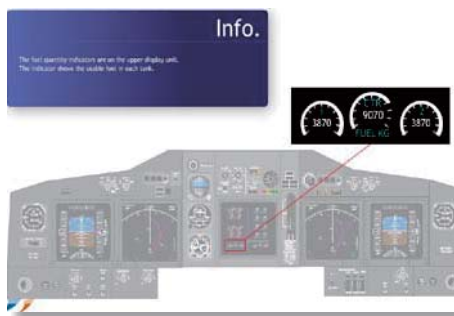

12. Fuel

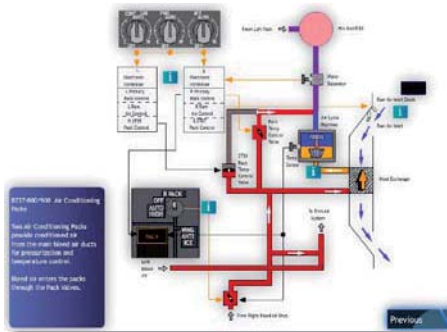

13. Air Conditioning



14. Lighting

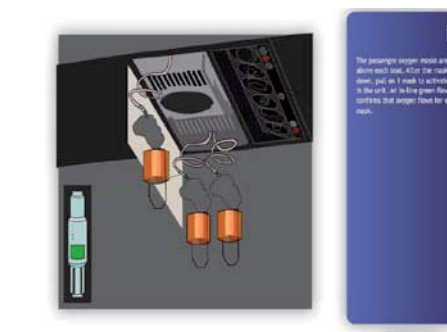

15. Oxygen

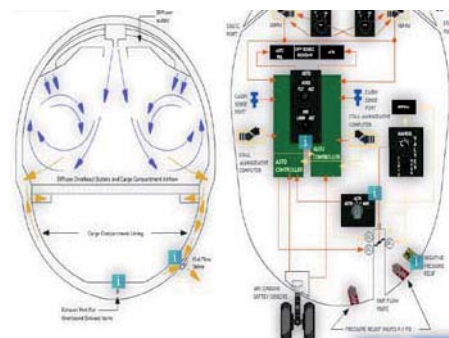

16. Pressurization

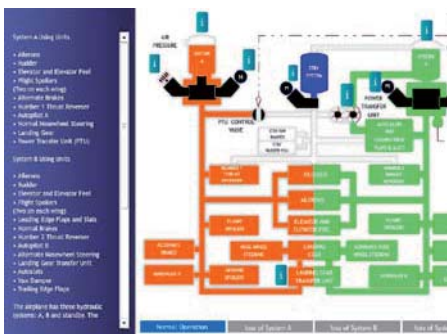

17. Hydraulics

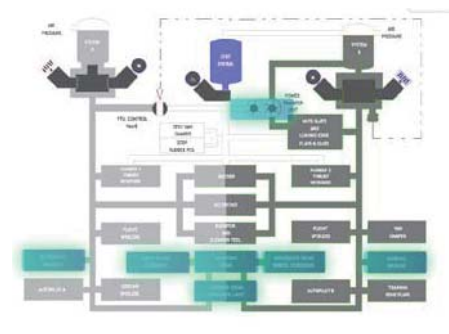

18. Landing Gear-Brake



19. Pneumatics

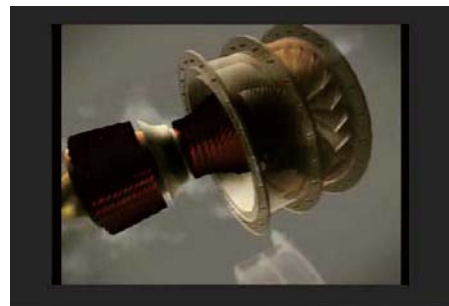

20. Propulsion

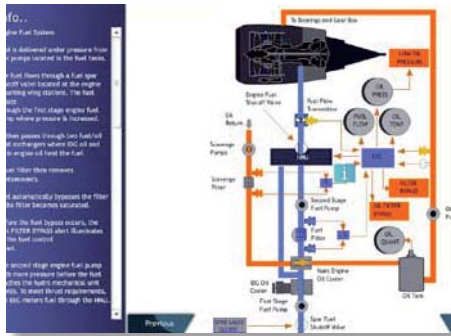

21. Engines

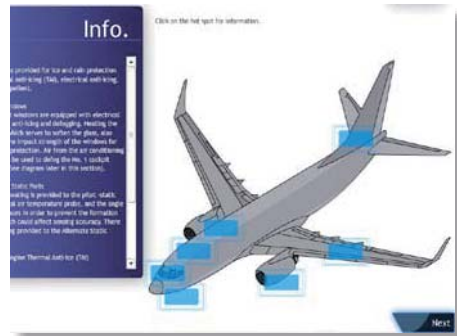

22. Ice-Rain Protection

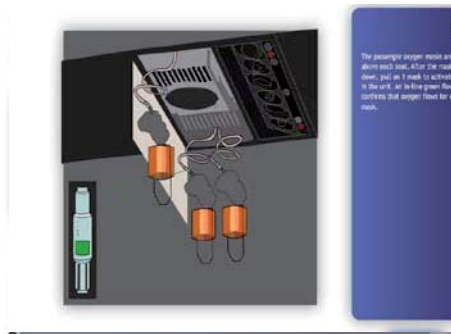

23. Fire Protection

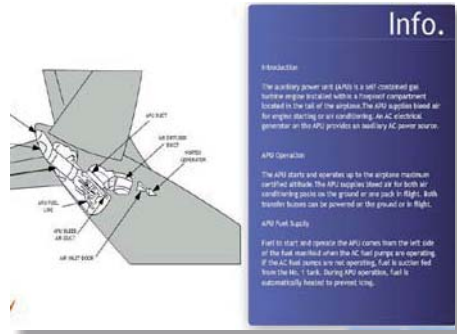

24. APU-Assist Power Unit

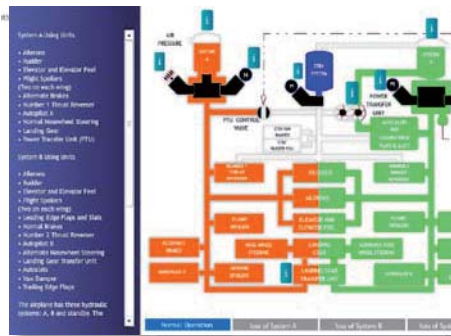

25. Warning System

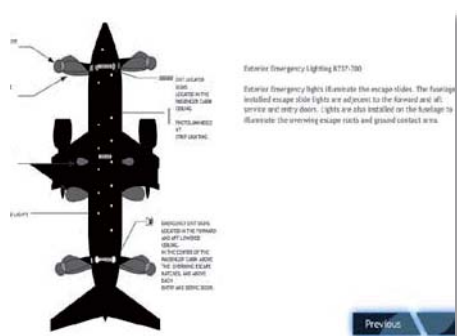

26. Emergency Equipments-General

● System requirement

1. PC : 1GHz or faster 32-bit (x86) or 64-bit (x64) processor, 1GB RAM, 300MB more free disk space
2. OS : Windows 7 / 8 / 10

K&H PRODUCTS® K&H MFG. CO., LTD.

5F., No. 8, Sec. 4, Ziqiang Rd., Sanchong Dist, New Taipei City 241, Taiwan (R.O.C.)
<http://www.kandh.com.tw> E-Mail: education@kandh.com.tw
 Tel : 886-2-2286-0700 (Rep.) 886-2-2286-7786
 Fax: 886-2-2287-3066, 886-2-2287-9704

SGS UKAS

K&H reserves the right to make changes without notice