

EMC Field Probes

User Manual



ETS-Lindgren L.P. reserves the right to make changes to any product described herein in order to improve function, design, or for any other reason. Nothing contained herein shall constitute ETS-Lindgren L.P. assuming any liability whatsoever arising out of the application or use of any product or circuit described herein. ETS-Lindgren L.P. does not convey any license under its patent rights or the rights of others.

© Copyright 2006–2013 by ETS-Lindgren L.P. All Rights Reserved. No part of this document may be copied by any means without written permission from ETS-Lindgren L.P.

Trademarks used in this document: The *ETS-Lindgren* logo, *ProbeView*, *LaserPro*, and *ProbeView II* are trademarks of ETS-Lindgren L.P.; *Microsoft* and *Windows* are registered trademarks of Microsoft Corporation in the United States and/or other countries.

Revision Record
MANUAL, EMC PROBES | Part #H-600100, Rev. K

Revision	Description	Date
A	Initial Release	December, 2006
B	Added <i>EC Declaration of Conformity</i> ; updated descriptions of I and r commands in <i>Operating Protocols</i> ; consistency/quality edits	January, 2007
C	Added FM5004 Field Monitor to <i>Introduction</i> ; added new sections, <i>Typical Configurations</i> and <i>HI-6153 Electric Field Probe</i> ; updated photos, specifications, battery replacement in <i>HI-6053 Field Probe</i> ; added HI-6153 to <i>Probe Stand</i> ; updated service procedures, safety notices	April, 2007
D	Updated <i>H-491269 Probe Stand</i>	November, 2007
E	Added information for HI-6022 and HI-6122 probes	March, 2008
F	Updated HI-6153 fiber optic connectors; branding updates	May, 2008
G	<ul style="list-style-type: none"> • Added HI-4413USB content • Added <i>ETSProbe DLL User Guide</i> 	October, 2009
H	Removed HI-4422 content; removed FM5004 content	October, 2010
I	Added <i>General Safety Considerations</i>	March, 2011
J	Updated <i>About Probe Operation</i>	June, 2011

Revision	Description	Date
K	<ul style="list-style-type: none"><li data-bbox="800 224 1157 248">• Updated <i>Specifications</i>: All probes<li data-bbox="800 272 1220 329">• Added <i>Typical Isotropic Response</i> charts: HI-6105, HI-6005, HI-6153, HI-6053<li data-bbox="800 354 1188 410">• Updated <i>Frequency Response</i> charts: All probes<li data-bbox="800 435 1167 459">• Updated <i>Additional Parts</i>: All probes<li data-bbox="800 483 1146 540">• Added laser shutoff information to <i>Laser-Powered Field Probes</i>	February, 2013

Table of Contents

Notes, Cautions, and Warnings	ix
General Safety Considerations	x
ETS-Lindgren Product Information Bulletin	x
1.0 Introduction	11
Readout Options.....	12
HI-6100 Field Monitor	12
HI-6113 Laser Data Interface	12
HI-4413P Fiber Optic Modem.....	13
HI-4413USB Fiber Optic to USB Converter	13
Optional Tripod	14
Optional Probe Stand.....	15
About Probe Operation	16
2.0 Typical Configurations	17
HI-6100 Field Monitor Configuration.....	18
HI-6113 Laser Data Interface Configuration	19
HI-4413P / HI-4413USB Configuration.....	20
3.0 Maintenance	21
Annual Calibration	21
Laser Probes and Maintenance of Fiber Optics.....	22
Upgrade Policies.....	22
Service Procedures	22
4.0 Laser-Powered Field Probes	23
HI-6122 Electric Field Probe	24
HI-6122 Specifications	24
HI-6122 Operation	25
HI-6122 Typical Frequency Response	26
HI-6122 Typical Isotropic Response.....	27
HI-6122 Additional Maintenance	28
HI-6122 Additional Parts	28
HI-6153 Electric Field Probe	30
HI-6153 Specifications	30
HI-6153 Operation	32
HI-6153 Typical Frequency Response	33

HI-6153 Typical Isotropic Response.....	34
HI-6153 Additional Maintenance	37
HI-6153 Additional Parts	37
HI-6105 Electric Field Probe	39
HI-6105 Specifications	39
HI-6105 Operation	40
HI-6105 Typical Frequency Response	41
HI-6105 Typical Isotropic Response.....	42
HI-6105 Additional Maintenance	43
HI-6105 Additional Parts	43
5.0 Battery-Operated Field Probes	45
HI-6022 Field Probe.....	46
HI-6022 Specifications	46
HI-6022 Operation	47
HI-6022 Power Switch	48
HI-6022 Typical Frequency Response	49
HI-6022 Typical Isotropic Response.....	50
HI-6022 Additional Maintenance	51
HI-6022 Additional Parts	51
HI-6053 Field Probe.....	53
HI-6053 Specifications	53
HI-6053 Operation	55
HI-6053 Power Switch	56
HI-6053 Controls.....	57
HI-6053 Typical Frequency Response	58
HI-6053 Typical Isotropic Response.....	59
HI-6053 Additional Maintenance	62
HI-6053 Battery Replacement.....	62
HI-6053 Additional Parts	64
HI-6005 Field Probe.....	66
HI-6005 Specifications	66
HI-6005 Operation	67
HI-6005 Power Switch	68
HI-6005 Typical Frequency Response	69
HI-6005 Typical Isotropic Response.....	70
HI-6005 Additional Maintenance	71

HI-6005 Additional Parts	71
6.0 H-491269 Probe Stand	73
Probe Stand Dimensions	73
Probe Stand Assembly	74
Parts to Assemble.....	74
Steps to Assemble.....	75
Probe Stand Operation	78
7.0 Probe Shield Care and Replacement	81
Appendix A: Warranty	83
Appendix B: Series H-491198-01 Battery Charger for NiMH Batteries.....	85
Appendix C: Series H-491198-48 Battery Charger for NiMH Batteries.....	93
Appendix D: Operating Protocols	101
Appendix E: ETSProbe DLL User Guide	111
About Redistribution.....	111
Getting Started.....	111
DLL Function Calling Conventions	112
Supported Probes and Communications Protocols	112
Probe Family HI-Any (Auto Probe Detector).....	116
Probe Family FP-Any (Auto Probe Detector FP)	116
Probe Family Virtual.....	116
Probe Family HI-44xx MS	117
Probe Family HI-6005 MS (Medium Speed).....	117
Probe Family HI-6005 HS (High Speed).....	118
Probe Family Laser HS (High Speed)	118
Probe Types Not Supported.....	118
Quick Start Function Reference	119
ETS_CreateProbe()	119
ETS_ReadFieldSynchronous().....	122
ETS_RemoveProbe().....	123
Advanced Function Reference.....	124
ETS_Battery()	124
ETS_CalibrationDate().....	125

ETS_CombinedField()	126
ETS_Field()	127
ETS_Firmware()	128
ETS_GetErrorDescription()	129
ETS_GetUnitsString()	130
ETS_InitiateReadBattery()	131
ETS_InitiateReadField()	132
ETS_InitiateReadTemperature()	133
ETS_IsOperationComplete()	134
ETS_Model()	135
ETS_ProbeName()	136
ETS_ReadBatterySynchronous()	137
ETS_ReadTemperatureSynchronous()	138
ETS_SerialNumber()	139
ETS_SetRange()	140
ETS_SetUnits()	141
ETS_TemperatureC()	142
ETS_LaserCurrent()	143
ETS_Version()	144
ETS_SupplyVoltage()	145
ETS_LaserTemperature()	146
ETS_ZeroProbe()	147
Status Codes	148
Appendix F: EC Declaration of Conformity	151

Notes, Cautions, and Warnings

	<p>Note: Denotes helpful information intended to provide tips for better use of the product.</p>
<p>CAUTION</p>	<p>Caution: Denotes a hazard. Failure to follow instructions could result in minor personal injury and/or property damage. Included text gives proper procedures.</p>
<p>WARNING</p>	<p>Warning: Denotes a hazard. Failure to follow instructions could result in SEVERE personal injury and/or property damage. Included text gives proper procedures.</p>



See the ETS-Lindgren *Product Information Bulletin* for safety, regulatory, and other product marking information.

General Safety Considerations

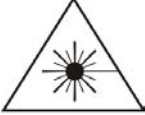
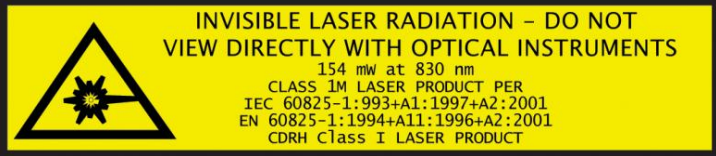
 <p>Class 1M</p>	<p>LASER HAZARD. Laser power up to 150 mW at 830 nm may be accessible at the fiber connector of the laser. However, the laser beam itself is not hazardous as the interlock ensures that the exposure time will be less than 30 ms.</p>
	



See the ETS-Lindgren *Product Information Bulletin* for safety, regulatory, and other product marking information.

ETS-Lindgren Product Information Bulletin

See the ETS-Lindgren *Product Information Bulletin* included with your shipment for the following:

- Warranty information
- Safety, regulatory, and other product marking information
- Steps to receive your shipment
- Steps to return a component for service
- ETS-Lindgren calibration service
- ETS-Lindgren contact information

1.0 Introduction

The **ETS-Lindgren EMC Field Probes** embody the latest innovations in isotropic sensor design and low-noise, miniaturized electronics. Each probe is a fully intelligent sensor enabling fast and accurate EMF measurements with industry-leading performance specifications. Optical coupling to a variety of readout options makes these probes ideally suited for a wide range of field monitoring applications.

The EMC field probes include laser-powered (laser) probes and battery-operated probes. This manual includes operating information and specifications for these probe models:

Laser-Powered	<ul style="list-style-type: none">• HI-6122• HI-6153• HI-6105
Battery-Operated	<ul style="list-style-type: none">• HI-6022• HI-6053• HI-6005



ETS-Lindgren may substitute a similar part or new part number with the same functionality for another part/part number. Contact ETS-Lindgren for questions about part numbers and ordering parts.

Readout Options

HI-6100 FIELD MONITOR

The HI-6100 Field Monitor accepts inputs from up to any four probes, and analyzes and displays information on a user-configurable LCD.

The HI-6100 may be used in conjunction with both the laser and battery-operated probes.



HI-6100 Field Monitor

For information on using the HI-6100 with ETS-Lindgren probes, see *HI-6100 Field Monitor Configuration* on page 18.

HI-6113 LASER DATA INTERFACE

The laser probes and the HI-6113 Laser Data Interface together communicate with ProbeView™ Laser software through a USB port on the computer.



HI-6113 Laser Data Interface

For information on using the HI-6113 with ETS-Lindgren probes, see *HI-6113 Laser Data Interface Configuration* on page 19.

HI-4413P FIBER OPTIC MODEM

The battery-powered probes use the HI-4413P Fiber Optic Modem to communicate with ProbeView II™ software through a serial port on the computer.



HI-4413P Fiber Optic Modem

For information on using the HI-4413P with ETS-Lindgren probes, see *HI-4413P / HI-4413USB Configuration* on page 20.

HI-4413USB FIBER OPTIC TO USB CONVERTER

The battery-powered probes use the HI-4413USB Fiber Optic to USB Converter to communicate with ProbeView II™ software through a USB port on the computer.



HI-4413USB Fiber Optic to USB Converter

For information on using the HI-4413USB with ETS-Lindgren probes, see *HI-4413P / HI-4413USB Configuration* on page 20.

Optional Tripod

The H-491009 Dielectric Tripod is the preferred method for mounting field probes for making unperturbed field measurements. It provides stable placement for one probe, and includes a 1/4–20 UNC threaded stud for mounting any ETS-Lindgren probe with a tripod mount. It is designed with an adjustable center post and a rotating mount.



Optional Probe Stand

The ETS-Lindgren Probe Stand may also be used in testing configurations. The probe stand supports up to two probes. For complete information on probe stand assembly and operation, see *H-491269 Probe Stand* on page 73.



About Probe Operation



For information on reducing measurement uncertainties and selecting the best field probe for your application see the white paper *Practical Considerations for Radiated Immunities Measurement using ETS-Lindgren EMC Field Probes*. This document is located on the ETS-Lindgren website at: www.ets-lindgren.com/whitepapers.



For complete information on setting up and operating the field monitor, software, and other devices available for the laser and battery-operated field probes, please see the documentation provided with those products.



Field probes are nominally rated for operation within a specific frequency range, but may also respond to signals above and below those frequencies. A probe may exhibit response to frequencies below the lower end of the range, and may also respond to frequencies above the upper end of the range, though not consistently or predictably.



Keep all conductive objects away from laser-powered and battery-operated probes. Conductive objects in the proximity of the probe can distort the near field and compromise measurement accuracy. If the application requires measurements from a fixed position, always mount the probe on a non-metallic platform, using non-metallic screws.

2.0 Typical Configurations

A variety of configurations are available with the field monitors, probes, and other devices. Following are typical examples of how the components can be assembled to accommodate most testing environments.

HI-6100 Field Monitor Configuration

The following diagram illustrates the ETS-Lindgren probes that may be used with the HI-6100 Field Monitor. In the diagram, the **FM** in **HI-6153FM**, for example, refers to *Field Monitor Kit*. As a kit, the probe includes an interface card.

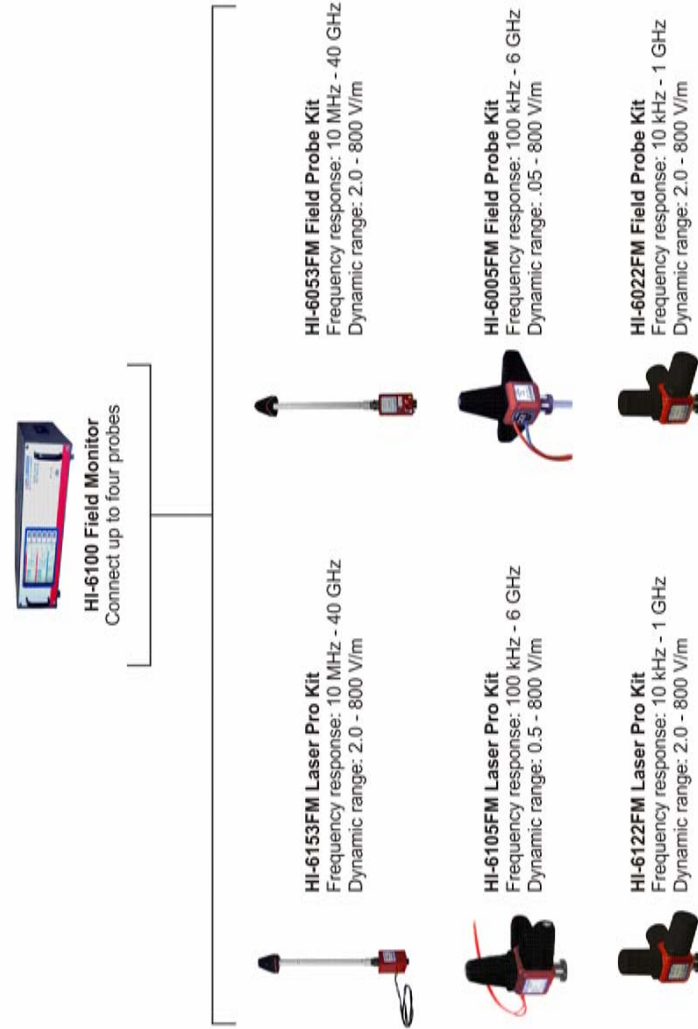

HI-6113 Laser Data Interface Configuration

The following diagram illustrates the ETS-Lindgren probes that may be used with the HI-6113 Laser Data Interface (LDI). In the diagram, the **USB** in **HI-6153USB**, for example, refers to *USB Kit*. As a kit, the probe includes all components required to operate the probe with the HI-6113.

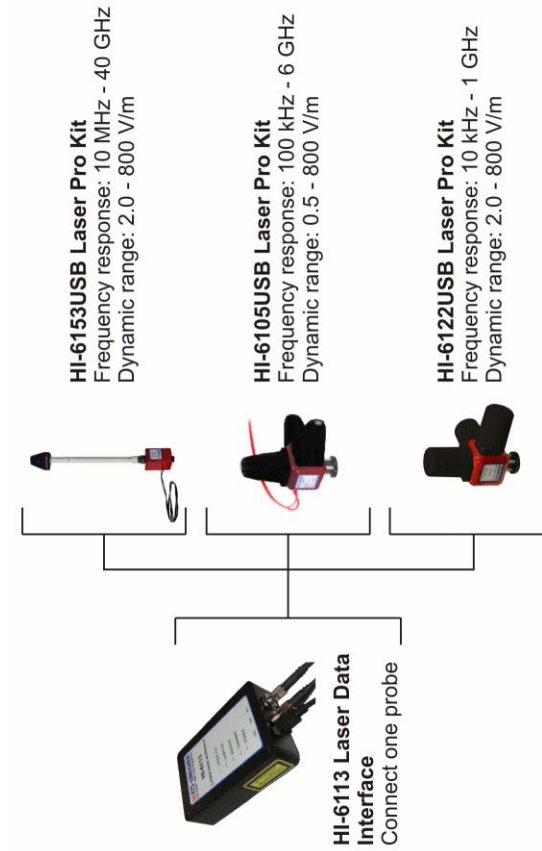

HI-4413P / HI-4413USB Configuration

The following diagram illustrates the ETS-Lindgren probes that may be used with the HI-4413P Fiber Optic Modem or the HI-4413USB Fiber Optic to USB Converter.

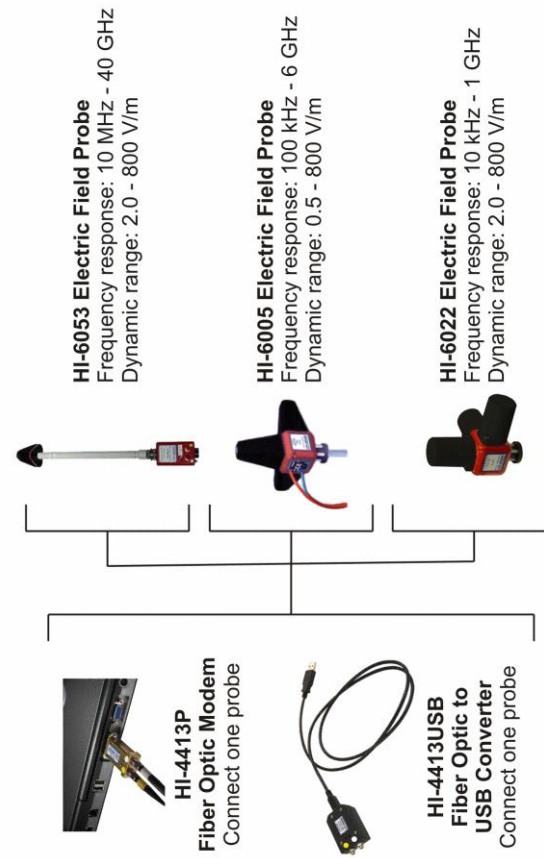

3.0 Maintenance

CAUTION

Before performing any maintenance, follow the safety information in the ETS-Lindgren *Product Information Bulletin* included with your shipment.



Maintenance of probes is limited to external components such as cables or connectors.

Warranty may be void if the housing is opened.

If you have any questions concerning maintenance, contact ETS-Lindgren Customer Service.

If you have one of the following probes, see *Probe Shield Care and Replacement* on page 81: HI-6122, HI-6022, HI-6105, or HI-6005 Field Probe.

Annual Calibration

See the *Product Information Bulletin* included with your shipment for information on ETS-Lindgren calibration services.

Laser Probes and Maintenance of Fiber Optics

The fiber optic connectors and cables used with laser-powered probes can be damaged from airborne particles, humidity and moisture, oils from the human body, and debris from the connectors they plug into. Always handle connectors and cables with care, using the following guidelines.



Before performing any maintenance, disconnect the fiber optic cables from the unit and turn off power.

When disconnecting fiber optic cables, apply the included dust caps to the ends to maintain their integrity.

Before connecting fiber optic cables, clean the connector tips and in-line connectors.

Before attaching in-line connectors, clean them with moisture-free compressed air.

Failure to perform these tasks may result in damage to the fiber optic connectors or cables.

Upgrade Policies

Periodically, probes are upgraded to enhance functionality. Contact ETS-Lindgren Customer Service for the upgrade status of your probe.

Service Procedures

For the steps to return a system or system component to ETS-Lindgren for service, see the *Product Information Bulletin* included with your shipment.

4.0 Laser-Powered Field Probes

The HI-61XX Series LaserPro™ Field Probe is a laser-powered probe, an excellent tool for electric field mapping, industrial monitoring, and EMC field measurements.

The HI-61XX Series probes contain a photo-voltaic converter that provides power to the probe circuitry when sufficient light power is received by the converter. The light power is generated by a laser in the HI-6113 Laser Data Interface, and is transmitted to the converter through an optical fiber in the duplex fiber optic cable. The probe communicates with the HI-6113 through this fiber optic cable. Receiving power from the HI-6113 allows for unlimited test times.

The probe system incorporates a safety interlock mechanism that turns off the laser if the HI-6113 does not receive data from the probe within a specified time frame. The safety mechanism is intended to prevent injury from the laser if the HI-6113 issues a command to turn on the laser while the fiber optic cables are disconnected, improperly connected, cut, or damaged.



The laser driver in the HI-6100 Field Monitor also incorporates this safety interlock mechanism, and operates in the same manner.

The HI-6100 Field Monitor may also be used with the HI-61XX Series for RFI/EMC testing. For more information on readout options, see page 12.

HI-6122 Electric Field Probe



The **ETS-Lindgren HI-6122 Field Probe** provides broadband frequency coverage and wide dynamic range that satisfies the demands of most test requirements.

The frequency response of the HI-6122 is 10 kHz to 1 GHz, and the dynamic range is 2 to 800 Volts per meter (V/m).

HI-6122 SPECIFICATIONS

Dynamic Range:	2.0 – 800 Volts per meter (V/m)
Ranges:	Single
Typical Frequency Response:	<u>10 kHz–1 GHz</u> <ul style="list-style-type: none">• 10 kHz–30 kHz: +0.5 dB, -2.5 dB• 30 kHz–1 GHz: ± 1 dB
Typical Frequency Response with Correction:	10 kHz–1 GHz: ± 0.9 dB
Linearity:	± 0.5 dB @ 27 MHz
Isotropy:	± 0.5 dB @ 400 MHz
Overload Withstand:	> 1,500 V/m CW

Physical Interface:	<ul style="list-style-type: none"> • Duplex optical fiber (62.5 micron multimode) • FC connectors for laser cable, integral 1-m optical cable • ST connector for transmitter cable, integral 1-m optical cable
Probe Mount:	1/4–20 UNC tapped hole (internal thread)
Environmental	
Operating Temperature:	10°C to 40°C 50°F to 104°F
Humidity:	5% to 95% relative humidity, non-condensing
Dimensions	
Housing:	32 mm x 32 mm x 32 mm 1.26 in x 1.26 in x 1.26 in
Probe Shields:	36 mm (1.42 in)
Weight:	80 g (2.82 oz)

HI-6122 OPERATION

The HI-6122 can be used with the HI-6100 Field Monitor. It can also be connected to a personal computer using an optional HI-6113 Laser Data Interface and ProbeView™ Laser software.

The HI-6122 is a true 3-axis probe. When requested, X, Y, Z, and total field data can be reported.

For a list and description of communication and information transfer protocols, including command structure, probe commands, and HI-6113 commands, see *Appendix D: Operating Protocols* on page 101.

HI-6122 TYPICAL FREQUENCY RESPONSE



TEM Cell and GTEM! – Field Level 20 V/m

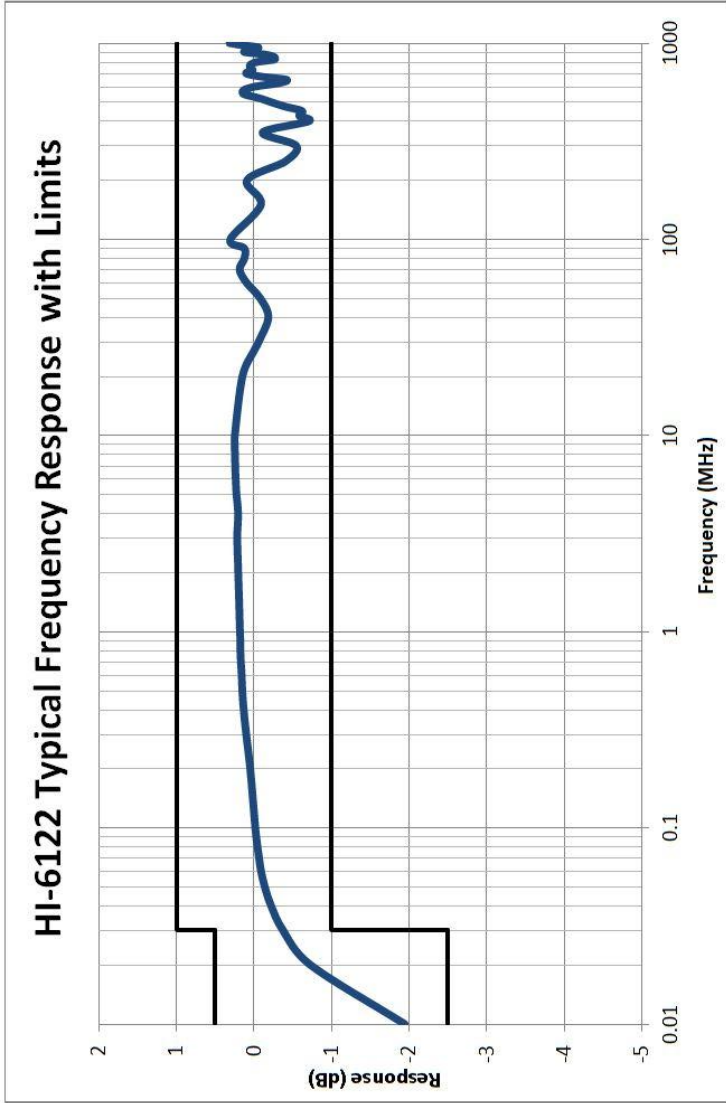

HI-6122 TYPICAL ISOTROPIC RESPONSE



Isotropic response measured in a 20 V/m field at 400 MHz.

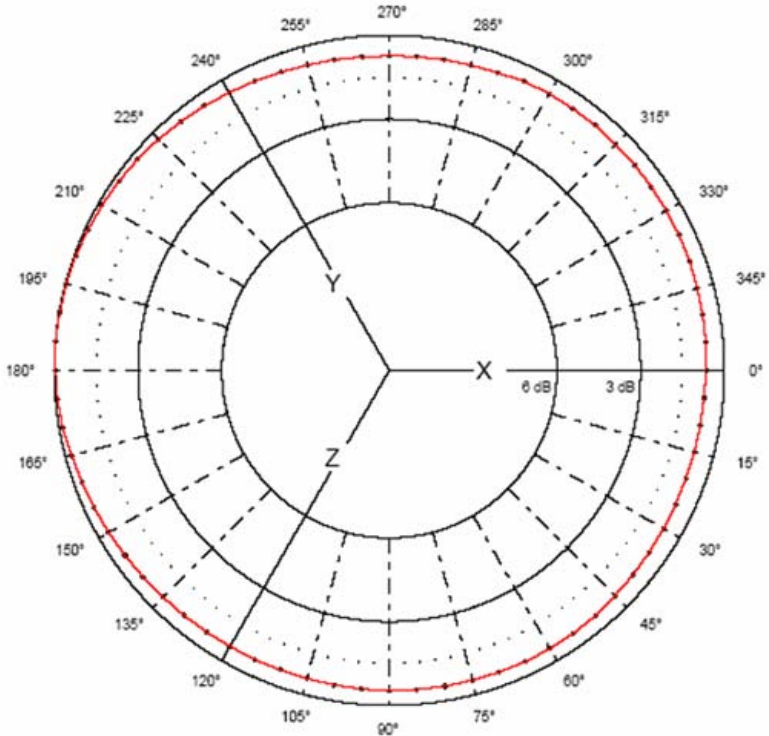

HI-6122 ADDITIONAL MAINTENANCE

Maintenance of the HI-6122 is limited to external components such as cables, connectors, and probe shields. For information on fiber optic cable and connector maintenance, see *Laser Probes and Maintenance of Fiber Optics* on page 22. To replace the probe shields, see *Probe Shield Care and Replacement* on page 81.



Any maintenance or calibration task requires probe disassembly, which may void your warranty. Only ETS-Lindgren service personnel should perform these tasks. To avoid problems with your warranty, contact ETS-Lindgren Customer Service before performing any maintenance.

For complete information on maintenance and calibration, see *Maintenance* on page 21.

HI-6122 ADDITIONAL PARTS

Use the following table to order replacement or optional parts for the HI-6122.

Part Description	Part Number
Probe shield replacement Kit includes: <ul style="list-style-type: none">• Three probe shields (cones)• One each X, Y, and Z label• Six screws	112955
Cable Assembly, Fiber, FC-FC, ST-ST	H-491263-xx (xx=length in meters)
FC to FC Inline Connector	H-23861521000
ST to ST Inline Connector	708027
Carrying Case	H-491291
HI-6100 Field Monitor	HI-6100

Part Description	Part Number
Laser Data Interface	HI-6113
Tripod, Dielectric	H-491009
Probe Stand	H-491269
Fiber Optic Cleaning System	H-34FO1
Laser System Fiber Optic Maintenance Kit	112333
Probe Carrier for H-491269 Probe Stand	H-491276

HI-6153 Electric Field Probe



The **ETS-Lindgren HI-6153 Field Probe** provides broadband frequency coverage and wide dynamic range that satisfies the demands of most test requirements.

The frequency response of the HI-6153 is 10 MHz to 40 GHz, and the dynamic range is 2 to 800 Volts per meter (V/m).

HI-6153 SPECIFICATIONS

Dynamic Range:	2.0–800 Volts per meter (V/m)
Ranges:	Single
Typical Frequency Response:	<u>10 MHz–40 GHz</u> <ul style="list-style-type: none">• 10 MHz–100 MHz: +3 dB, -4 dB• 100 MHz–1 GHz: +3 dB, -0.5 dB• 1 GHz–18 GHz: +4 dB, -2 dB• 18 GHz–40 GHz: +3.5 dB, -4.5 dB
Typical Frequency Response with Correction:	<ul style="list-style-type: none">• 10 MHz–18 GHz: ± 0.9 dB• 18 GHz–40 GHz: ± 1.1 dB
Linearity:	± 0.5 dB @ 1 GHz
Isotropy:	± 1.0 dB < 18 GHz

Overload Withstand:	1,500 V/m
Physical Interface:	<ul style="list-style-type: none"> • Duplex optical fiber (62.5 micron multimode) • FC connectors for laser cable, integral 1-m optical cable • ST connector for transmitter cable, integral 1-m optical cable
Probe Mount:	1/4–20 UNC tapped hole (internal thread)
Environmental	
Operating Temperature:	10°C to 40°C 50°F to 104°F
Humidity:	5% to 95% relative humidity, non-condensing
Dimensions	
Probe Length:	438 mm (17.24 in) (includes electronics housing)
Probe Diameter:	57 mm (2.24 in)
Weight:	0.36 kg (12.64 oz)

HI-6153 OPERATION



The HI-6153 assembly consists of a pyramidal casing containing the sensor, which is mounted on one end of a shaft. The other end of the shaft is attached to an extrusion that houses the electronics. The sensor and electronics housing operate and are calibrated as a unit.



The HI-6153 is a true 3-axis probe. When requested, X, Y, Z, and total field data can be reported.

The HI-6153 can be used with the HI-6100 Field Monitor. It can also be connected to a personal computer using an optional HI-6113 Laser Data Interface and ProbeView™ Laser software.

For a list and description of communication and information transfer protocols, including command structure, probe commands, and HI-6113 commands, see *Appendix D: Operating Protocols* on page 101.

HI-6153 TYPICAL FREQUENCY RESPONSE



Field Level 20 V/m

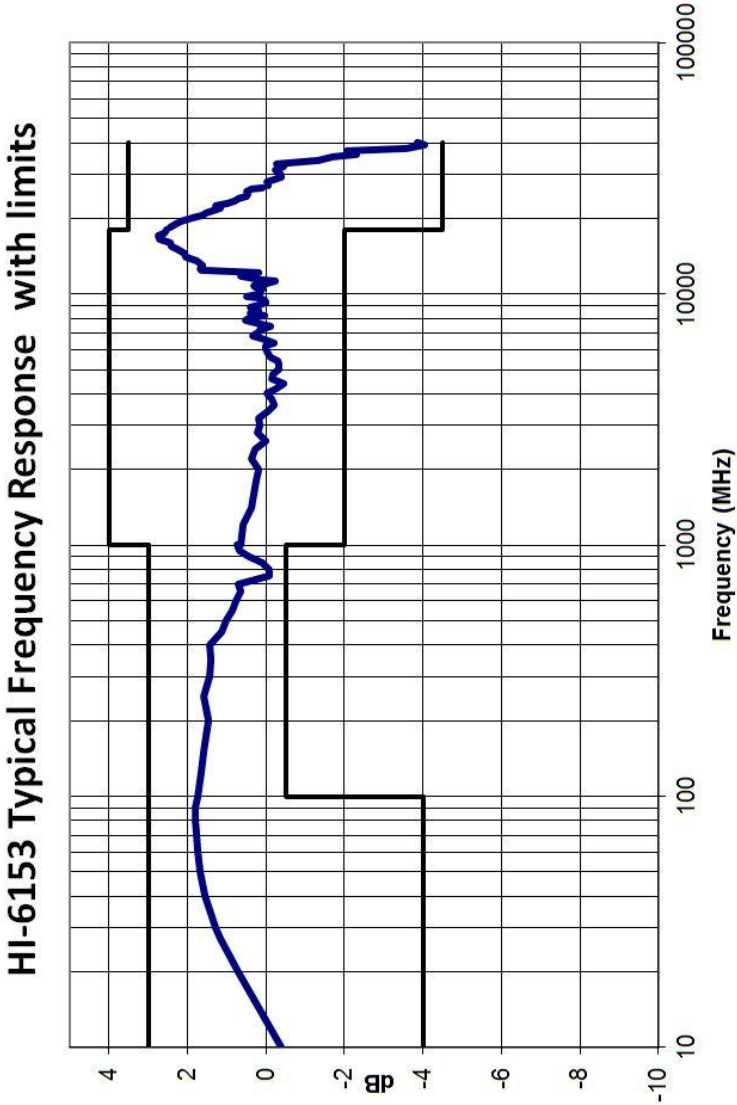

HI-6153 TYPICAL ISOTROPIC RESPONSE

Typical Isotropic Response in dB at 1 GHz

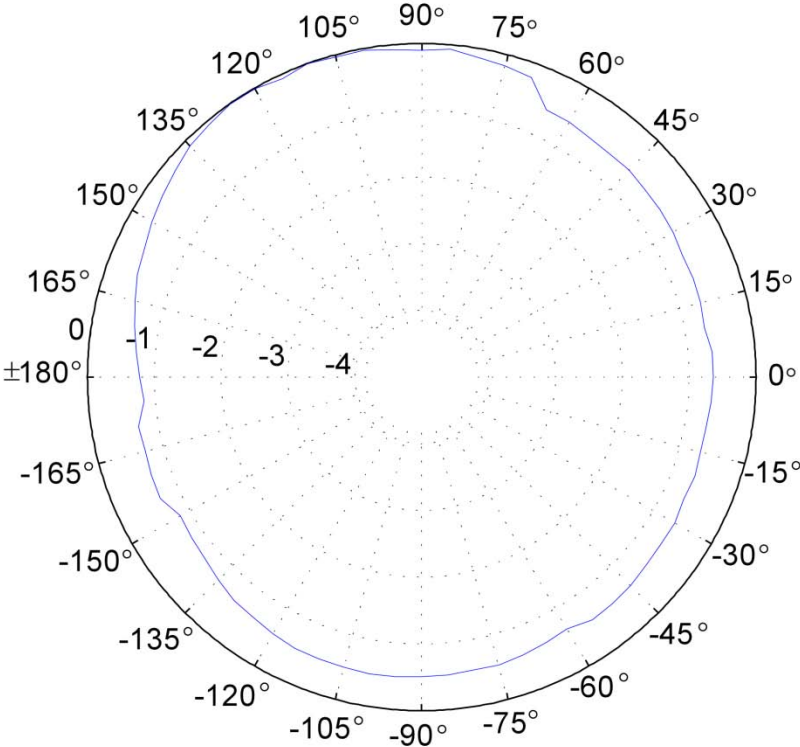

Typical Isotropic Response in dB at 10 GHz

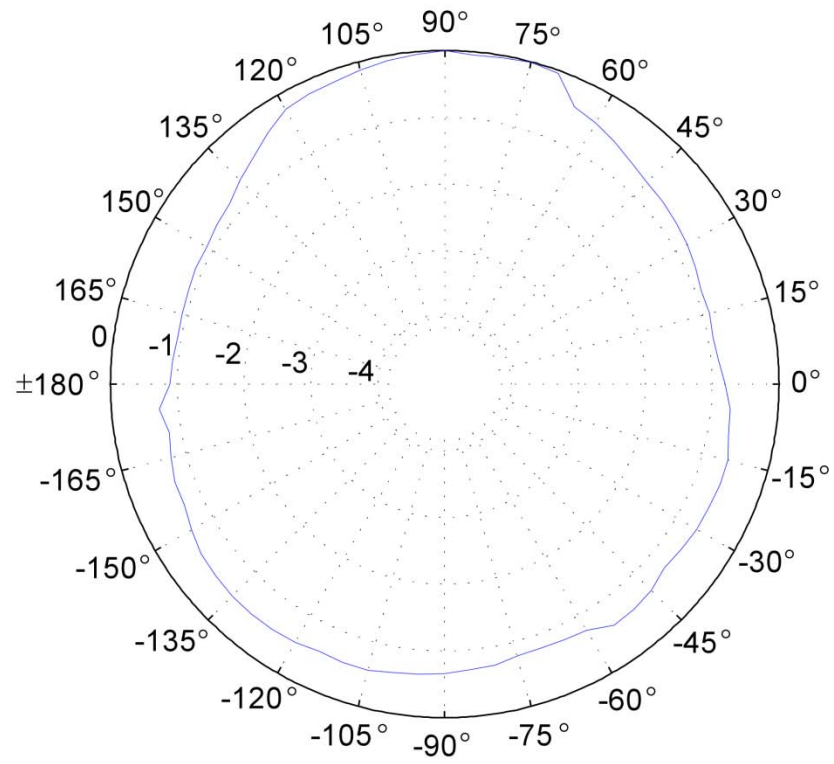

Typical Isotropic Response in dB at 18 GHz

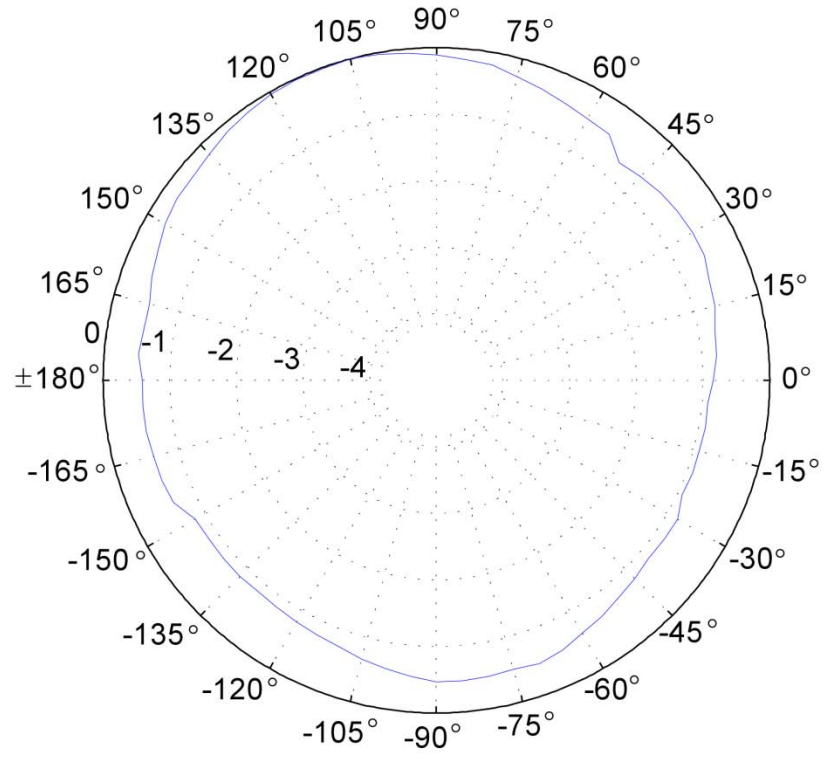

HI-6153 ADDITIONAL MAINTENANCE

Maintenance of the HI-6153 is limited to external components such as cables and connectors. For information on fiber optic cable and connector maintenance, see *Laser Probes and Maintenance of Fiber Optics* on page 22.



Any maintenance or calibration task requires probe disassembly, which may void your warranty. Only ETS-Lindgren service personnel should perform these tasks. To avoid problems with your warranty, contact ETS-Lindgren Customer Service before performing any maintenance.

For complete information on maintenance and calibration, see *Maintenance* on page 21.

HI-6153 ADDITIONAL PARTS

Use the following table to order replacement or optional parts for the HI-6153.

Part Description	Part Number
Cable Assembly, Fiber, FC-FC, ST-ST	H-491263-xx (xx=length in meters)
FC to FC Inline Connector	H-23861521000
ST to ST Inline Connector	708027
Carrying Case	H-491291
HI-6100 Field Monitor	HI-6100
HI-6113 Laser Data Interface	HI-6113
H-491009 Tripod, Dielectric, Field Probe	H-491009
H-491269 Probe Stand	H-491269
Fiber Optic Cleaning System	H-34FO1

Part Description	Part Number
Laser System Fiber Optic Maintenance Kit	112333
Probe Carrier for H-491269 Probe Stand	H-491276

HI-6105 Electric Field Probe



The **ETS-Lindgren HI-6105 Electric Field Probe** is a fully intelligent sensor enabling fast and accurate EMF measurements with industry-leading performance specifications. Optical coupling to a variety of readout options makes this probe ideally suited for a wide range of field monitoring applications.

HI-6105 SPECIFICATIONS

Dynamic Range:	0.5–800 Volts per meter (V/m) Single Range (64 dB)
Typical Frequency Response:	<u>100 kHz–6 GHz</u> <ul style="list-style-type: none">• 500 kHz–2 GHz: +1 dB, -2.5 dB• 2 GHz–5.5 GHz: +3.5 dB, -4 dB• 5.5 GHz–6 GHz: +2 dB, -6 dB
Typical Frequency Response with Correction:	100 kHz–6 GHz: ± 0.9 dB
Linearity:	± 0.5 dB @ 27 MHz
Isotropy:	± 0.5 dB @ 400 MHz
Overload Withstand:	1,500 V/m

Physical Interface:	<ul style="list-style-type: none"> • Duplex optical fiber (62.5 micron multimode) • FC connectors for laser cable, integral 1-m optical cable • ST connector for transmitter cable, integral 1-m optical cable
Probe Mount:	1/4–20 UNC (internal thread)
Dimensions	
Housing:	32 mm x 32 mm x 32 mm 1.26 in x 1.26 in x 1.26 in
Probe Shields:	43 mm (1.69 in)
Weight:	0.08 kg (2.6 oz.)
Environmental	
Operating Temperature:	10°C to 40°C 50°F to 104°F
Humidity:	5% to 95% relative humidity, non-condensing

HI-6105 OPERATION

The HI-6105 can be used with the HI-6100 Field Monitor. It can also be connected to a personal computer using an optional HI-6113 Laser Data Interface (LDI) and ProbeView™ Laser software.

For a list and description of communication and information transfer protocols, including command structure, probe commands, and HI-6113 commands, see *Appendix D: Operating Protocols* on page 101.

HI-6105 TYPICAL FREQUENCY RESPONSE



Anechoic Room and TEM Cell – Field Level 20 V/m

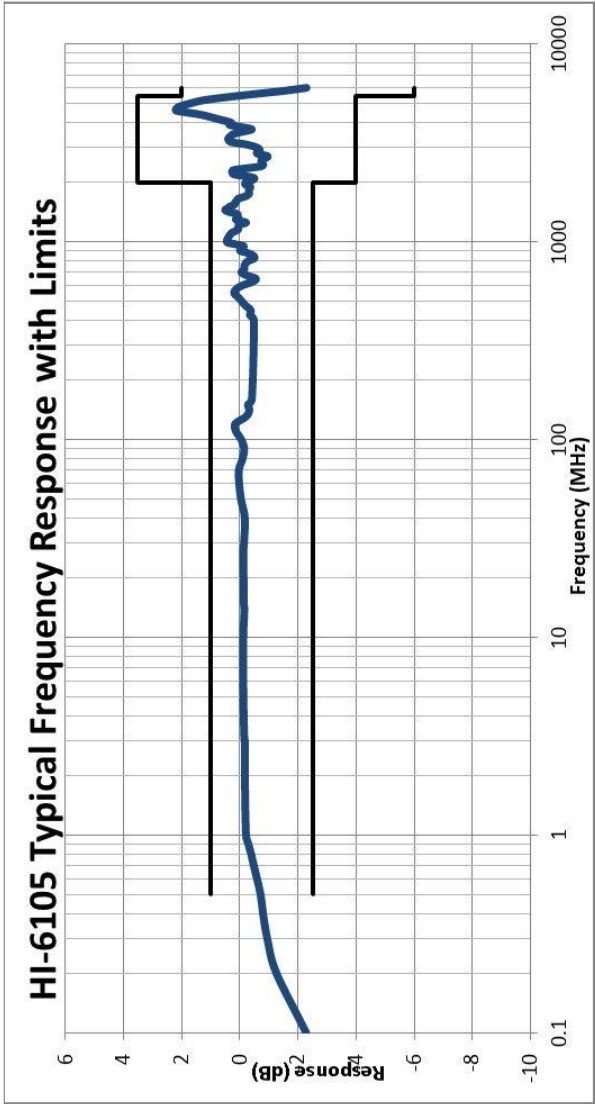

HI-6105 TYPICAL ISOTROPIC RESPONSE



Actual data taken at 400 MHz, field level 20 V/m, maximum variation 0.54 dB.

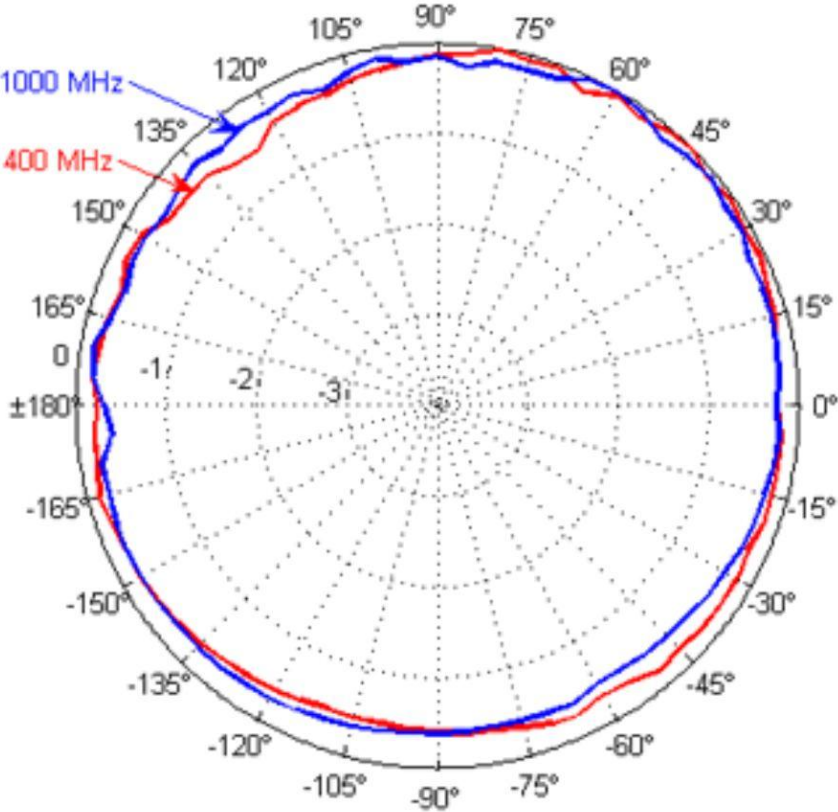

HI-6105 ADDITIONAL MAINTENANCE

Maintenance of the HI-6105 is limited to external components such as cables, connectors, and probe shields. For information on fiber optic cable and connector maintenance, see *Laser Probes and Maintenance of Fiber Optics* on page 22. To replace the probe shields, see *Probe Shield Care and Replacement* on page 81.



Any maintenance or calibration task requires probe disassembly, which may void your warranty. Only ETS-Lindgren service personnel should perform these tasks. To avoid problems with your warranty, contact ETS-Lindgren Customer Service before performing any maintenance.

For complete information on maintenance and calibration, see *Maintenance* on page 21.

HI-6105 ADDITIONAL PARTS

Use the following tables to order replacement or optional parts for the HI-6105.

Part Description	Part Number
Probe shield replacement Kit includes: <ul style="list-style-type: none">• Three probe shields (cones)• One each X, Y, and Z label• Six screws	H-491237
Cable Assembly, Fiber, FC-FC, ST-ST	H-491263-xx (xx=length in meters)
FC to FC Inline Connector	H-23861521000
ST to ST Inline Connector	708027

Part Description	Part Number
Tripod, Dielectric	H-491009
HI-6100 Field Monitor	HI-6100
Laser Data Interface	HI-6113
Probe Stand	H-491269
Fiber Optic Cleaning System	H-34FO1
Laser System Fiber Optic Maintenance Kit	112333
Probe Carrier for H-491269 Probe Stand	H-491276

5.0 Battery-Operated Field Probes



Before using your battery-operated probe, read the following:

HI-6053 Field Probe: *Appendix B: Series H-491198-01 Battery Charger* on page 85.

HI-6022 and HI-6005 Field Probe: *Appendix C: Series H-491198-48 Battery Charger* on page 93.



To calibrate the probe prior to shipment, ETS-Lindgren also charges the internal battery at the factory. Every effort is made to make sure that the probe arrives ready to use, but you should verify the condition of the battery prior to making any measurements.

The HI-60XX Series Field Probe is a battery-operated probe that utilizes three orthogonal sensors to provide an isotropic reading of the electric field. When requested, X, Y, Z, and total field data can be reported, making the HI-60XX Series true 3-axis probes.

The HI-60XX Series uses either the HI-4413P Fiber Optic Modem or the HI-4413USB Fiber Optic to USB Converter to communicate with ProbeView II™ software through a port on the computer. The HI-6100 Field Monitor may also be used with the HI-60XX Series. For more information on readout options, see page 12.

HI-6022 Field Probe



The **ETS-Lindgren HI-6022 Field Probe** provides broadband frequency coverage and wide dynamic range that satisfies the demands of most test requirements.

The frequency response of the HI-6022 is 10 kHz to 1 GHz, and the dynamic range is 2 to 800 Volts per meter (V/m).

HI-6022 SPECIFICATIONS

Dynamic Range:	2.0–800 Volts per meter (V/m)
Ranges:	Single
Typical Frequency Response:	<u>10 kHz–1 GHz</u> <ul style="list-style-type: none">• 10 kHz–30 kHz: +0.5 dB, -2.5 dB• 30 kHz–1 GHz: ± 1 dB
Typical Frequency Response with Correction:	10 kHz–1 GHz: ± 0.9 dB
Linearity:	± 0.5 dB @ 27 MHz
Isotropy:	± 0.5 dB @ 400 MHz
Overload Withstand:	> 1,500 V/m CW
Fiber Optic Cable Connector:	Standard FSMA
Probe Mount:	1/4–20 UNC tapped hole (internal thread)

Battery:	Rechargeable Nickel-Metal Hydride (NiMH)
Battery Life:	Up to 8 hours
Battery Charger:	<ul style="list-style-type: none"> • 100–240 VAC universal input • 3-hour charge from full depletion
Environmental	
Operating Temperature:	10°C to 40°C 50°F to 104°F
Humidity:	5% to 95% relative humidity, non-condensing
Dimensions	
Housing:	32 mm x 32 mm x 32 mm 1.26 in x 1.26 in x 1.26 in
Probe Shields:	36 mm (1.42 in)
Weight:	80 g (2.82 oz)

HI-6022 OPERATION

The HI-6022 can be used with the HI-6100 Field Monitor. It can also be connected to a personal computer using an optional HI-4413P Fiber Optic Modem or HI-4413USB Fiber Optic to USB Converter and ProbeView II™ software.

The HI-6022 is a true 3-axis probe. When requested, X, Y, Z, and total field data can be reported.

For a list and description of communication and information transfer protocols, including command structure and probe commands, see *Appendix D: Operating Protocols* on page 101.

HI-6022 POWER SWITCH

The power switch activates and deactivates the HI-6022:

- **ON (I)**—When the power switch is in the **I** position, an internal 4.8 VDC Nickel-Metal Hydride (NiMH) battery provides power to the probe, and the power indicator LED blinks.
- **OFF (O)**—When the power switch is in the **O** position, the probe is inactive. To prolong battery life, set the switch to **OFF** when the probe is not in use.

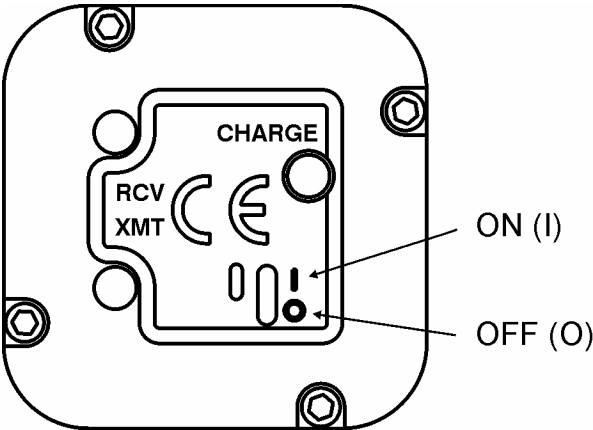

HI-6022 TYPICAL FREQUENCY RESPONSE



TEM Cell and GTEM! – Field Level 20 V/m

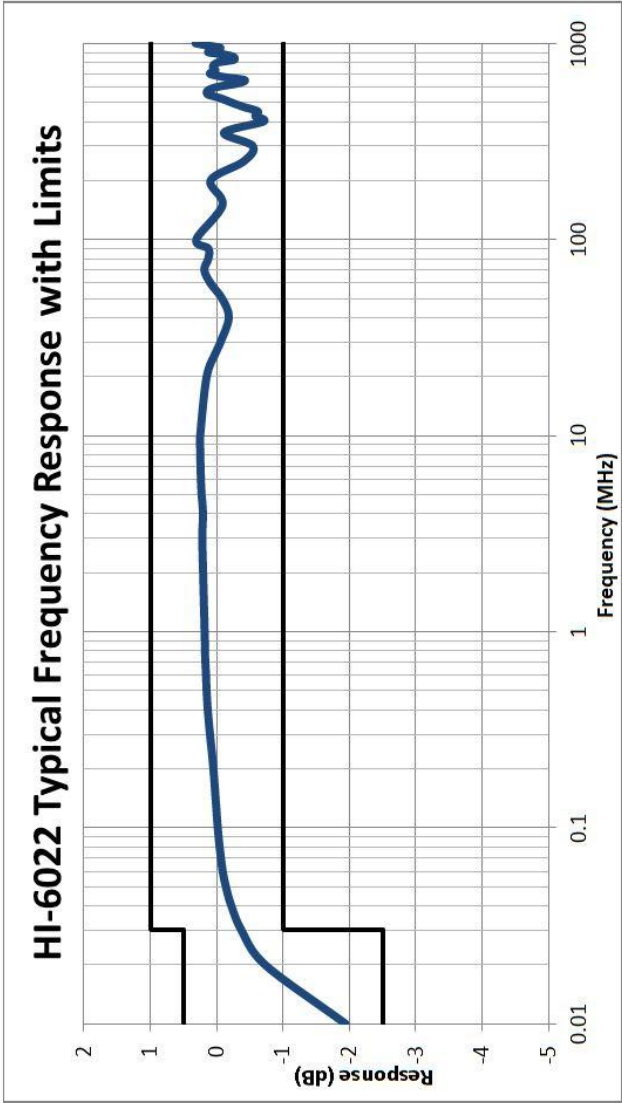

HI-6022 TYPICAL ISOTROPIC RESPONSE



Isotropic response measured in a 20 V/m field at 400 MHz.

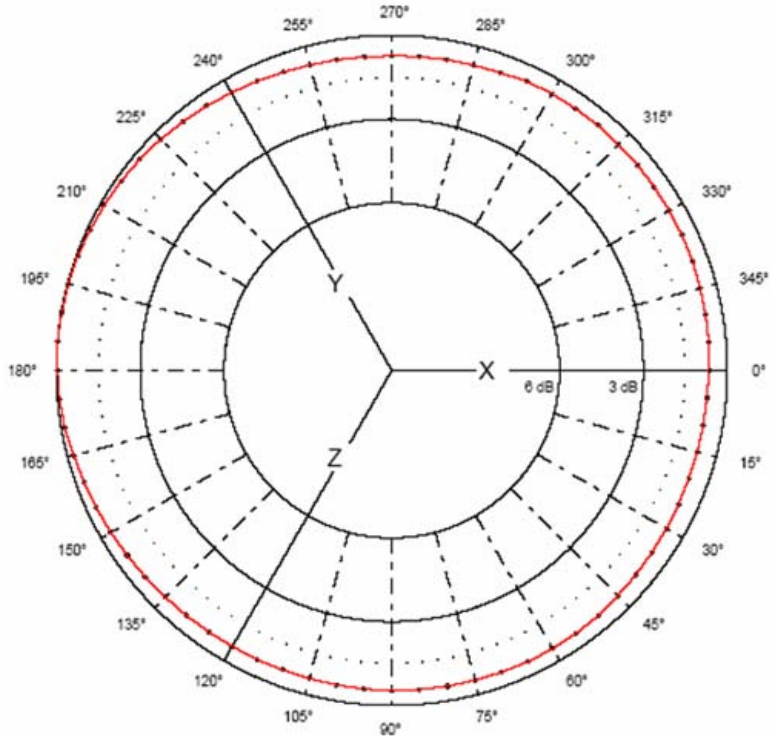

HI-6022 ADDITIONAL MAINTENANCE

Maintenance of the HI-6022 is limited to external components such as cables, connectors, and probe shields. To replace the probe shields, see *Probe Shield Care and Replacement* on page 81.



Any maintenance or calibration task requires probe disassembly, which may void your warranty. Only ETS-Lindgren service personnel should perform these tasks. To avoid problems with your warranty, contact ETS-Lindgren Customer Service before performing any maintenance.

For complete information on maintenance and calibration, see *Maintenance* on page 21.

HI-6022 ADDITIONAL PARTS

Use the following table to order replacement or optional parts for the HI-6022.

Optional Part Description	Part Number
Probe shield replacement Kit includes: <ul style="list-style-type: none">• Three probe shields (cones)• One each X, Y, and Z label• Six screws	112955
Cable, Fiber Optic, Glass	H-491106-xx (xx=length in meters)
Connector Set, two required (Bulkhead Feedthrough)	H-231205000
Fiber Optic Modem, RS-232 Interface	HI-4413P
Fiber Optic to USB Converter, USB Interface	HI-4413USB

Optional Part Description	Part Number
Battery Charger	H-491198-48
Carrying Case	H-491291
Tripod, Dielectric	H-491009
HI-6100 Field Monitor	HI-6100
Probe Stand	H-491269
Probe Carrier for H-491269 Probe Stand	H-491276

HI-6053 Field Probe



The ETS-Lindgren HI-6053 Field Probe provides broadband frequency coverage and wide dynamic range that satisfies the demands of most test requirements.

The frequency response of the HI-6053 is 10 MHz to 40 GHz, and the dynamic range is 2 to 800 Volts per meter (V/m).

HI-6053 SPECIFICATIONS

Dynamic Range:	2.0–800 Volts per meter (V/m)
Ranges:	Single
Typical Frequency Response:	<u>10 MHz–40 GHz</u> <ul style="list-style-type: none">• 10 MHz–100 MHz: +3 dB, -4 dB• 100 MHz–1 GHz: +3 dB, -0.5 dB• 1 GHz–18 GHz: +4 dB, -2 dB• 18 GHz–40 GHz: +3.5 dB, -4.5 dB
Typical Frequency Response with Correction:	<ul style="list-style-type: none">• 10 MHz–18 GHz: ± 0.9 dB• 18 GHz–40 GHz: ± 1.1 dB
Linearity:	± 0.5 dB @ 1 GHz
Isotropy:	± 1.0 dB < 18 GHz

Overload Withstand:	1,500 V/m
Fiber Optic Cable Connector:	Standard FSMA
Probe Mount:	1/4–20 UNC tapped hole (internal thread)
Battery:	Four AAA batteries, rechargeable Nickel-Metal Hydride (NiMH)
Battery Charger:	100–240 VAC Approximately three hours
Battery Life:	> 30 hours continuous (at full charge)
Environmental	
Operating Temperature:	10°C to 40°C 50°F to 104°F
Humidity:	5% to 95% relative humidity, non-condensing
Dimensions	
Probe Length:	438 mm (17.24 in) (includes electronics housing)
Probe Diameter:	57 mm (2.24 in)
Weight:	0.36 kg (12.64 oz)

HI-6053 OPERATION



The HI-6053 assembly consists of a pyramidal casing containing the sensor, which is mounted on one end of a shaft. The other end of the shaft is attached to an extrusion that houses the electronics. The sensor and electronics housing operate and are calibrated as a unit.



The HI-6053 is a true 3-axis probe. When requested, X, Y, Z, and total field data can be reported.

The HI-6053 can be used with the HI-6100 Field Monitor. It can also be connected to a personal computer using an optional HI-4413P Fiber Optic Modem or HI-4413USB Fiber Optic to USB Converter and ProbeView II™ software.

For a list and description of communication and information transfer protocols, including command structure and probe commands, see *Appendix D: Operating Protocols* on page 101.

HI-6053 POWER SWITCH

The power button that activates and deactivates the HI-6053 is located on the bottom of the electronic housing. A green indicator light in the power button flashes when the probe is on.

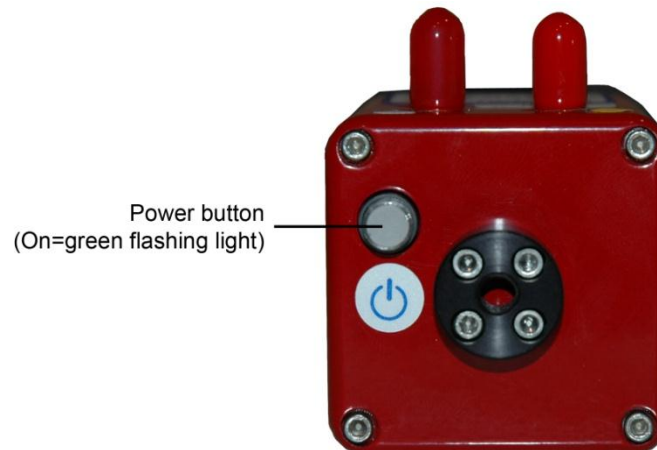

Bottom of HI-6053 Field Probe

- **On**—To turn the HI-6053 on, push in the power button, and then release. The power button flashes a green indicator light when the probe is on, and four AAA Nickel-Metal Hydride (NiMH) batteries supply power.
- **Off**—To turn the HI-6053 off, push in the power button, and then release. The green indicator light stops flashing, indicating the probe is off. When not in use, turn the probe off to prolong battery life.

HI-6053 CONTROLS

Two fiber optic connectors and a battery charger connector are mounted on the HI-6053 housing.



HI-6053 TYPICAL FREQUENCY RESPONSE



Field Level 20 V/m

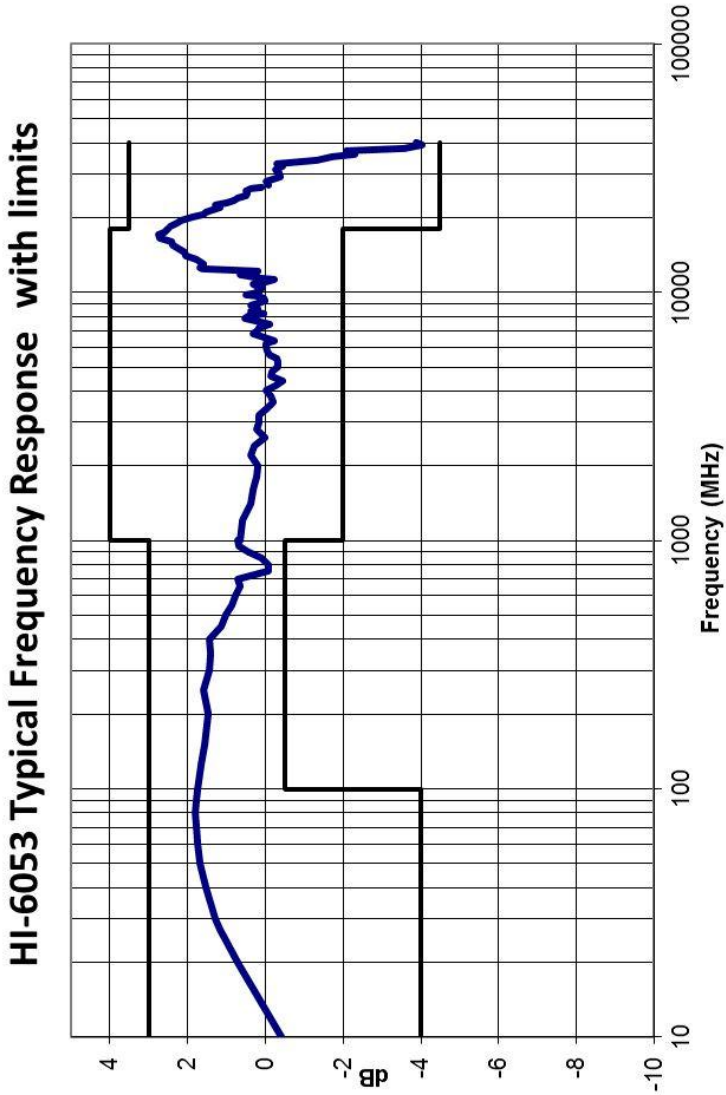

HI-6053 TYPICAL ISOTROPIC RESPONSE

Typical Isotropic Response in dB at 1 GHz

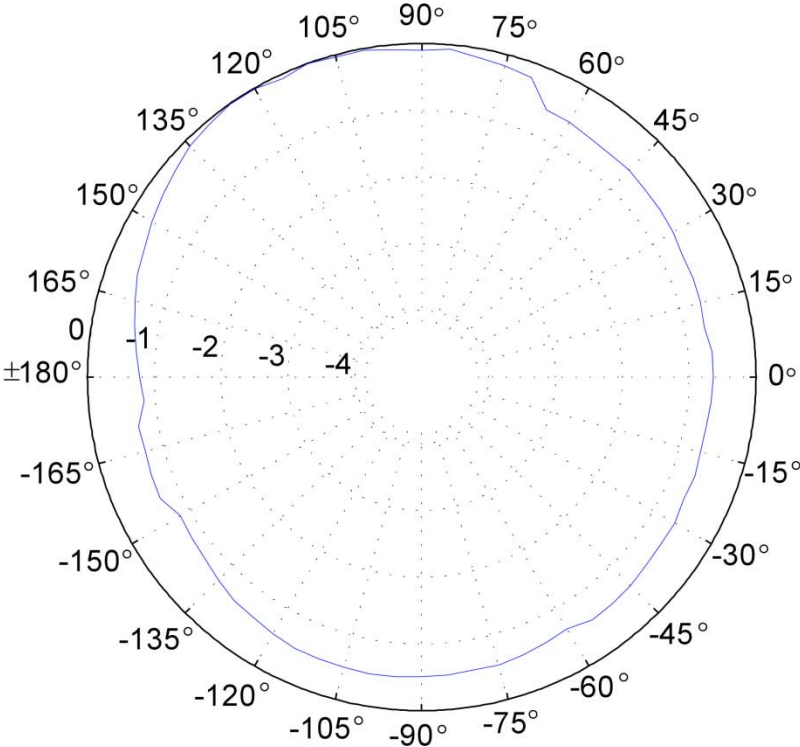

Typical Isotropic Response in dB at 10 GHz

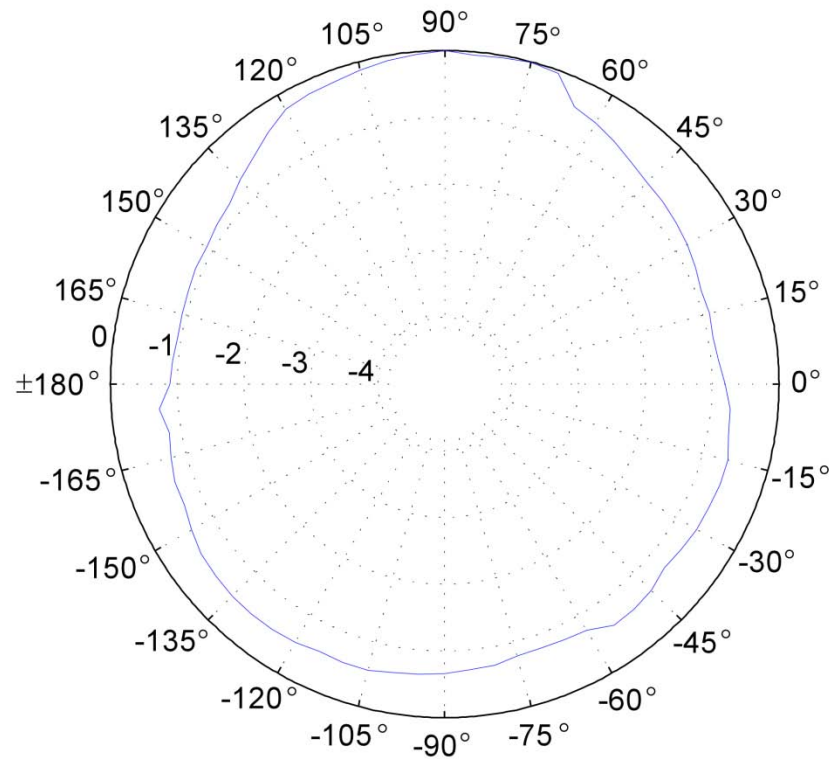

Typical Isotropic Response in dB at 18 GHz

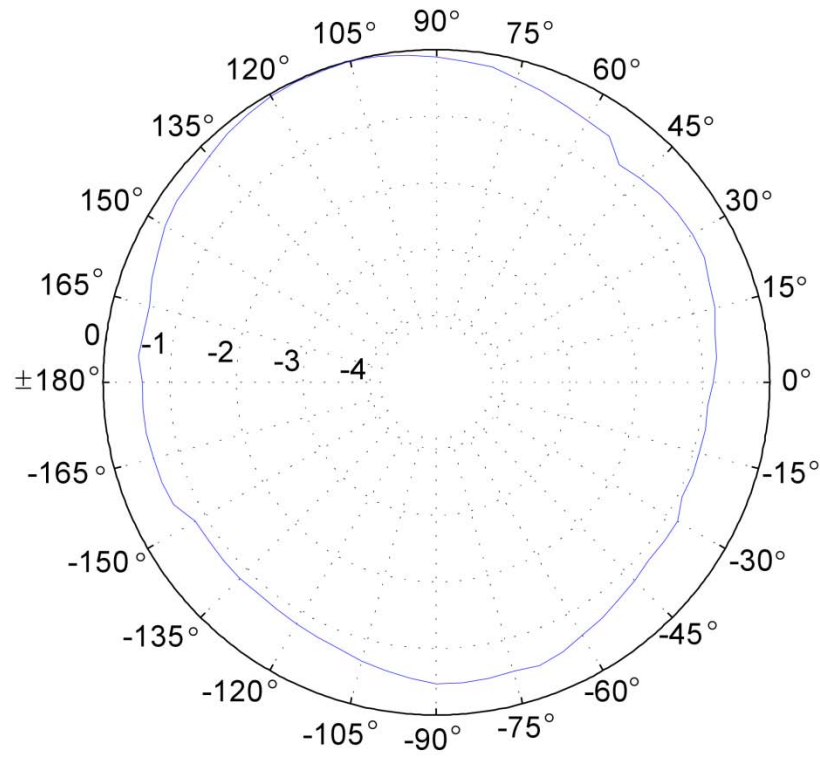

HI-6053 ADDITIONAL MAINTENANCE

Maintenance of the HI-6053 is limited to external components such as cables or connectors, and replacing the batteries. For complete information on replacing the batteries, see the next section, *HI-6053 Battery Replacement*.



Any other maintenance or calibration task requires probe disassembly, which may void your warranty. Only ETS-Lindgren service personnel should perform these tasks. To avoid problems with your warranty, contact ETS-Lindgren Customer Service before performing any maintenance.

For complete information on maintenance and calibration, see *Maintenance* on page 21.

HI-6053 BATTERY REPLACEMENT

During the annual calibration of your HI-6053 at the ETS-Lindgren factory, the batteries are tested to verify continued operability. If required, the batteries are replaced at that time. It is rare that you should need to replace the batteries between calibration checks, but in that event, follow these steps.



If you are not qualified to perform this procedure, please consult ETS-Lindgren Customer Service. ETS-Lindgren is not responsible for damage to the probe as a result of replacing the batteries.



See the *Product Information Bulletin* included with your shipment for information on ETS-Lindgren calibration services.

1. Turn the HI-6053 off. Verify that the green indicator light is not flashing.
2. Carefully disconnect the fiber optic cables from the **Transmit** and **Receive** connectors.
3. Remove the two nuts; one on each fiber optic connector.
4. Remove the four screws from the bottom of the electronics housing.
5. Lift the bottom away from the housing. Wires from the power button are connected to the internal circuitry, so carefully turn the bottom over and place it to the side, avoiding placing stress on the wires.

Board with four AAA rechargeable NiMH batteries

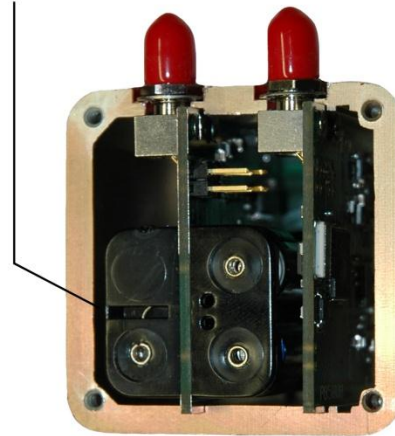

Inside HI-6053 housing
(Bottom plate with power button wires not shown)

6. A single connector attaches the two boards together. Withdraw the two boards from the housing at the same time. The boards should easily slide out of the tracks.
7. Detach the two boards by carefully separating them at the connector, avoiding damage to the pins.
8. Replace the four AAA rechargeable NiMH batteries, orienting the +/- ends as indicated.



Vertical board
with four batteries

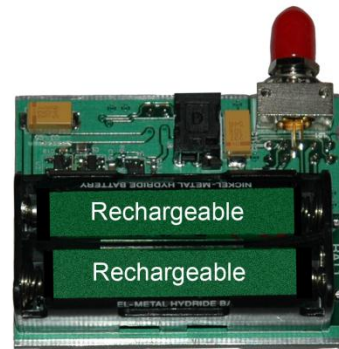

Horizontal board
with two batteries showing



Recycle the used batteries, or dispose of them safely and properly. Many cities collect used batteries for recycling or disposal. You may contact your local waste disposal agency for information on battery recycling and disposal.

9. Reattach the two boards at the connector.
10. Slide the two boards into the correct tracks inside the housing, and carefully push them until they are completely recessed.
11. Replace the bottom of the housing, avoiding damage to the power button wires.
12. Replace and tighten the four screws into the bottom of the housing.
13. Replace the two nuts removed in step 3; one on each fiber optic connector.

HI-6053 ADDITIONAL PARTS

Use the following table to order replacement or optional parts for the HI-6053.

Optional Part Description	Part Number
Cable, Fiber Optic, Glass	H-491106-xx (xx=length in meters)
Connector Set, two required (Bulkhead Feedthrough)	H-231205000
Fiber Optic / RS232 Interface	HI-4413P
Fiber Optic to USB Converter, USB Interface	HI-4413USB
Battery Charger	H-491198-01
Carrying Case	H-491291
Tripod, Dielectric	H-491009

Optional Part Description	Part Number
HI-6100 Field Monitor	HI-6100
Probe Stand	H-491269
Probe Carrier for H-491269 Probe Stand	H-491276

HI-6005 Field Probe



The **ETS-Lindgren HI-6005 Field Probe** is a fully intelligent sensor enabling fast and accurate EMF measurements with industry-leading performance specifications. Optical coupling to a variety of readout options makes this probe ideally suited for a wide range of field monitoring applications.

HI-6005 SPECIFICATIONS

Dynamic Range:	0.5–800 Volts per meter (V/m) Single Range (64 dB)
Typical Frequency Response:	<u>100 kHz–6 GHz</u> <ul style="list-style-type: none">• 500 kHz–2 GHz: +1 dB, -2.5 dB• 2 GHz–5.5 GHz: +3.5 dB, -4 dB• 5.5 GHz–6 GHz: +2 dB, -6 dB
Typical Frequency Response with Correction:	100 kHz–6 GHz: ±0.9 dB
Linearity:	±0.5 dB @ 27 MHz
Isotropy:	±0.5 dB @ 400 MHz
Overload Withstand:	1,500 V/m maximum Continuous field
Fiber Optic Cable Connectors:	Standard FSMA

Probe Mount:	1/4–20 UNC (internal thread)
Battery:	Rechargeable Nickel-Metal Hydride (NiMH)
Battery Charger:	100–240 VAC Approximately three hours
Dimensions	
Housing:	32 mm x 32 mm x 32 mm 1.26 in x 1.26 in x 1.26 in
Probe Shields:	43 mm (1.69 in)
Weight:	0.08 kg (2.6 oz)
Environmental	
Operating Temperature:	10°C to 40°C 50°F to 104°F
Humidity:	5% to 95% relative humidity, non-condensing

HI-6005 OPERATION

The HI-6005 can be used with the HI-6100 Field Monitor. It can also be connected to a personal computer using an optional HI-4413P Fiber Optic Modem or HI-4413USB Fiber Optic to USB Converter and ProbeView II™ software.

The HI-6005 is a true 3-axis probe. When requested, X, Y, Z, and total field data can be reported.

For a list and description of communication and information transfer protocols, including command structure and probe commands, see *Appendix D: Operating Protocols* on page 101.

HI-6005 POWER SWITCH

The power switch activates and deactivates the HI-6005:

- **ON (I)**—When the power switch is in the **I** position, an internal 4.8 VDC Nickel-Metal Hydride (NiMH) battery provides power to the probe, and the power indicator LED blinks.
- **OFF (O)**—When the power switch is in the **O** position, the probe is inactive. When not in use, turn the probe off to prolong battery life.

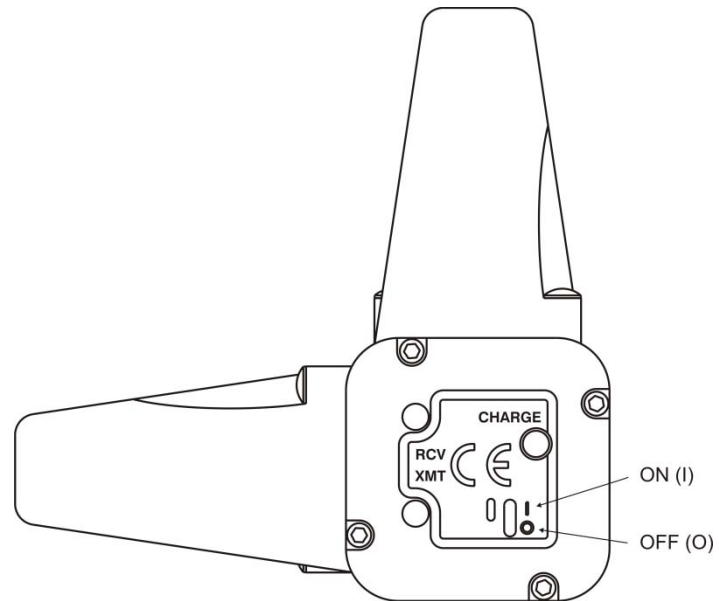

HI-6005 TYPICAL FREQUENCY RESPONSE



Anechoic Room and TEM Cell – Field Level 20 V/m

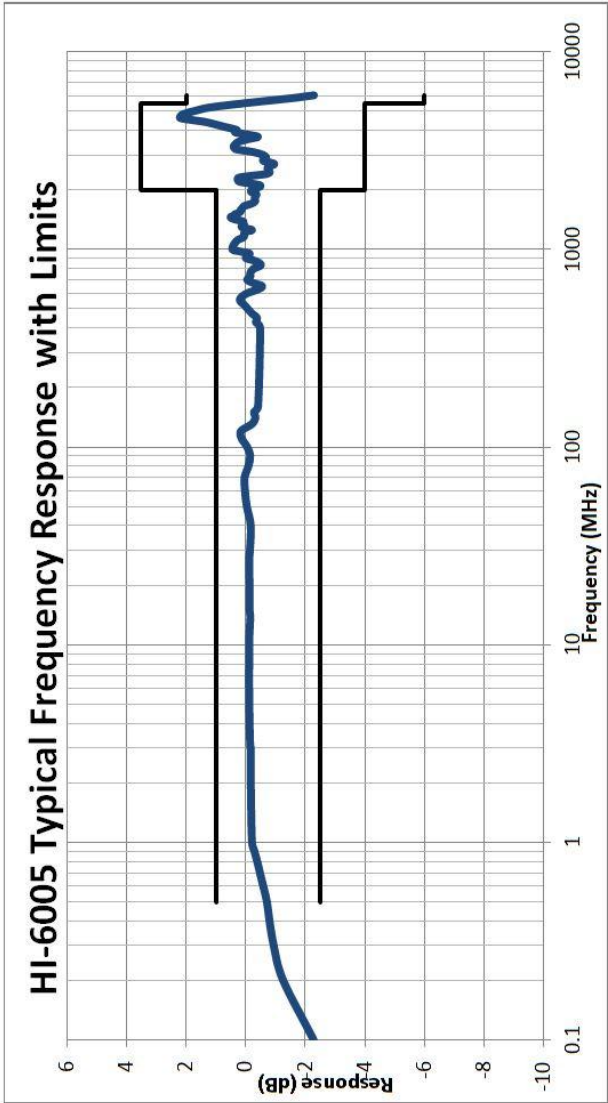

HI-6005 TYPICAL ISOTROPIC RESPONSE



Actual data taken at 400 MHz, field level 20 V/m, maximum variation 0.54 dB.

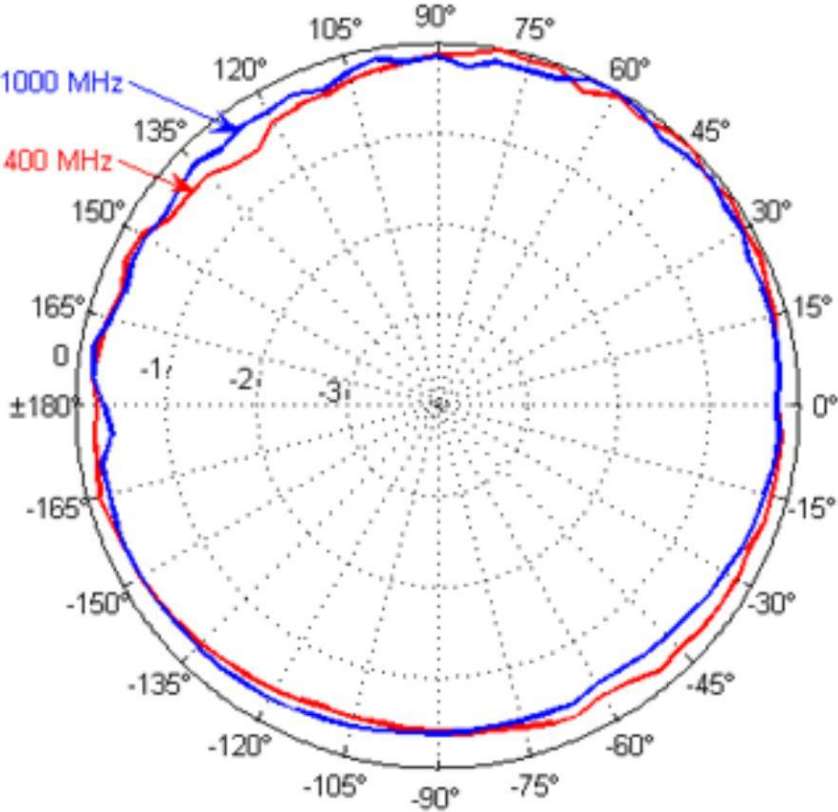

HI-6005 ADDITIONAL MAINTENANCE

Maintenance of the HI-6005 is limited to external components such as cables, connectors, and probe shields. To replace the probe shields, see *Probe Shield Care and Replacement* on page 81.



Any maintenance or calibration task requires probe disassembly, which may void your warranty. Only ETS-Lindgren service personnel should perform these tasks. To avoid problems with your warranty, contact ETS-Lindgren Customer Service before performing any maintenance.

For complete information on maintenance and calibration, see *Maintenance* on page 21.

HI-6005 ADDITIONAL PARTS

Use the following tables to order replacement or optional parts for the HI-6005.

Part Description	Part Number
Cone replacement Kit includes: <ul style="list-style-type: none">• Three cones• One each X, Y, and Z label• Six screws	H-651016
Battery Charger	H-491198-48
Carrying Case	H-491207
Cable, Fiber Optic, Glass	H-491106-xx (xx=length in meters)
Connector Set, two (Bulkhead Feedthrough)	H-231205000
Fiber Optic/RS232 Interface	HI-4413P
Fiber Optic to USB Converter, USB Interface	HI-4413USB

Part Description	Part Number
Tripod, Dielectric	H-491009
HI-6100 Field Monitor	HI-6100
Probe Stand	H-491269
Probe Carrier for H-491269 Probe Stand	H-491276

6.0 H-491269 Probe Stand

The **ETS-Lindgren Probe Stand** is designed for EMC testing in anechoic chambers and shielded enclosures. The probe stand provides stable placement for up to two probes.

PROBE STAND DIMENSIONS

Base Plate and Tube Height:	2438 mm 96 in
Tube Height:	2248 mm 88.50 in
Base Width:	406 mm 16 in
Tube Width:	51 mm 2 in



(Probe Stand shown assembled)

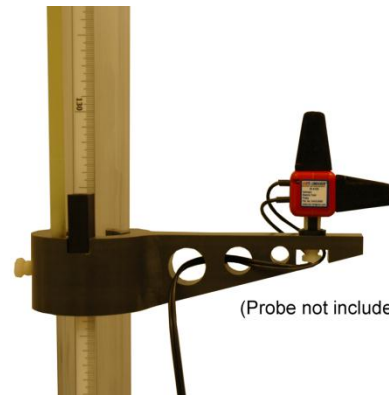

(Probe not included)

Probe Stand Assembly

PARTS TO ASSEMBLE

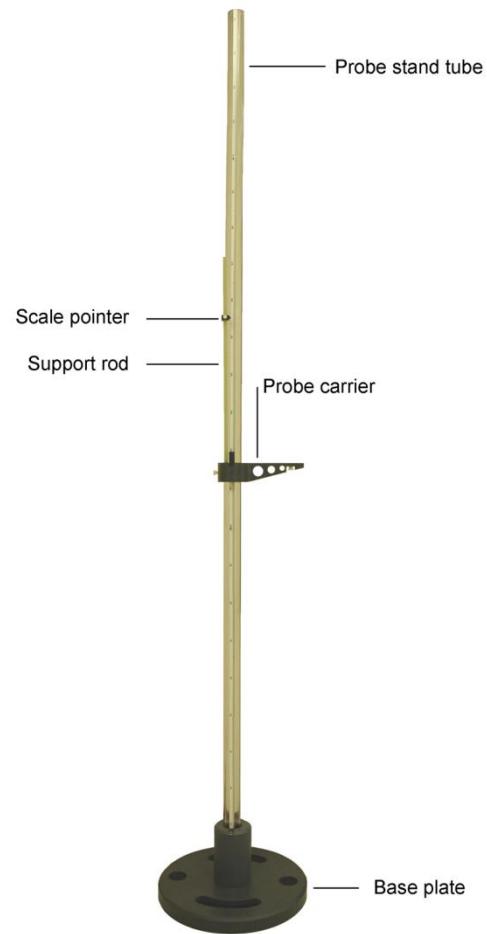

In addition to these parts, the probe stand includes the following assembly hardware:

- Locking knobs (4)
- 1/4–20 x 3/4-inch thumbscrews (2)
- 10–32 x 5/8-inch set screw
- 8–32 x 3/8-inch thumbscrew

STEPS TO ASSEMBLE

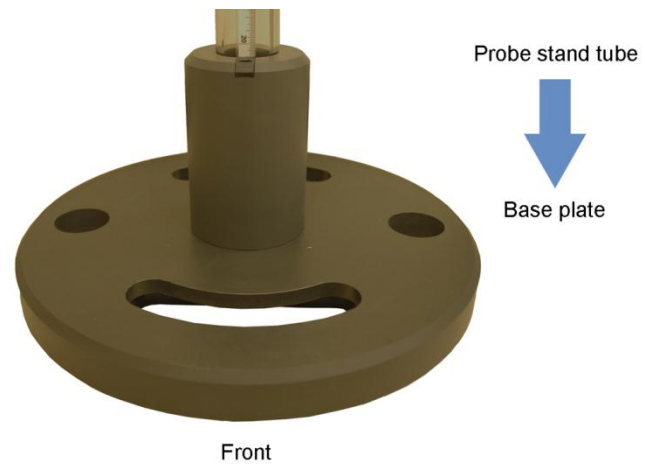

1. Insert the probe stand tube into the base plate.



- For accurate measurements, make sure to completely insert the probe stand tube into the base plate. When fully inserted, the bottom of the tube should rest evenly on the floor or surface.
- On the bottom of the base plate are rubber feet. Make sure all feet rest evenly on the floor or surface.
- Incorrect tube placement or an uneven base can cause inaccurate measurements.

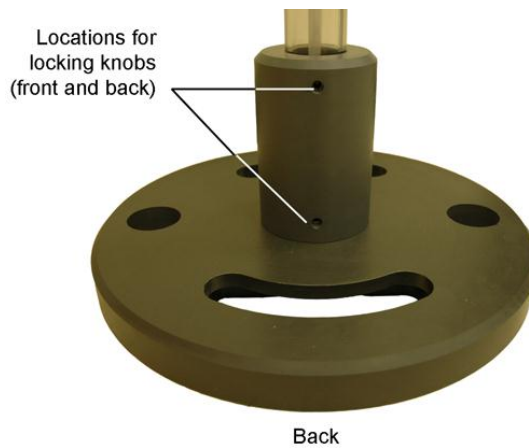

2. To stabilize the tube, insert and tighten the two locking knobs into their locations.

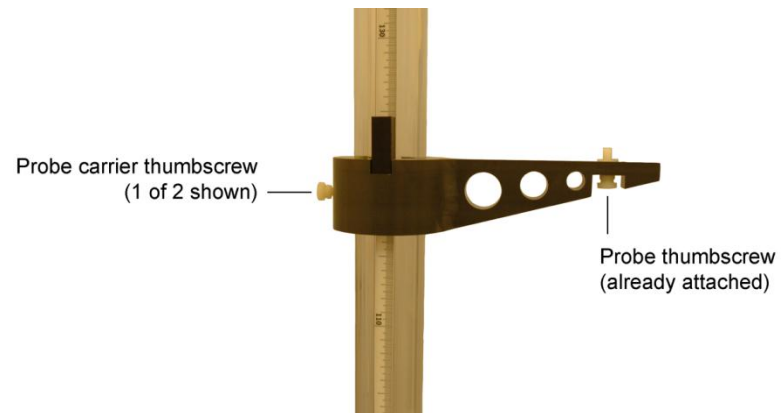

3. Attach the probe carrier to the tube. Insert one 1/4–20 x 3/4 thumbscrew into the end closer to the tube, and a second one at the center of the tube. Tighten the thumbscrews.



Testing can be performed using two probes simultaneously. If you ordered an optional second probe carrier, attach the additional probe carrier by repeating step 3.

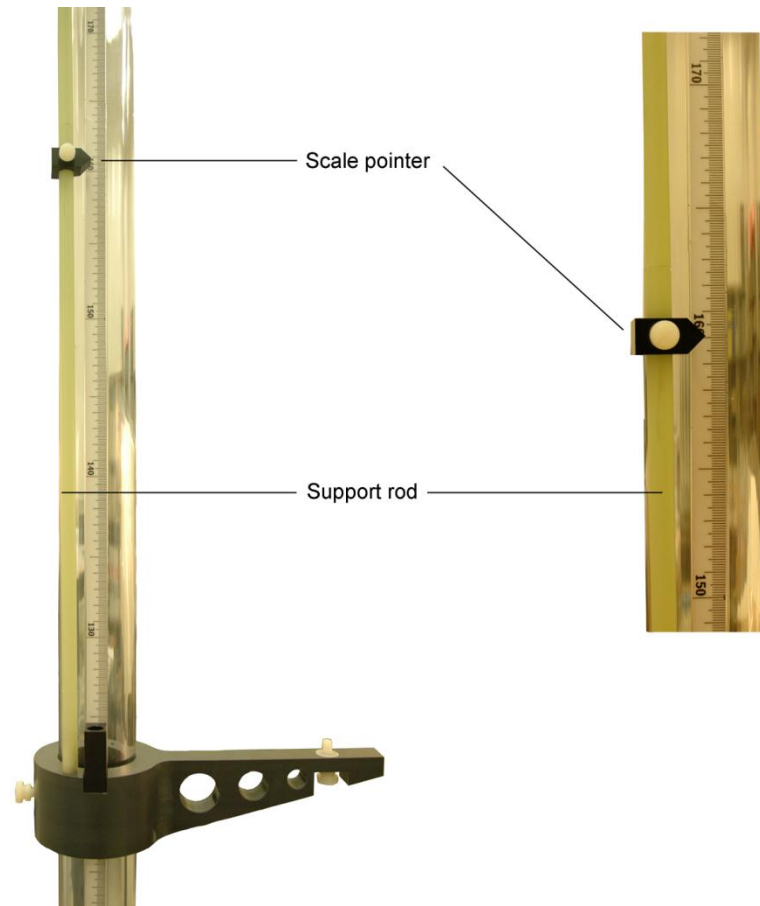

4. Attach the scale pointer to the tube with the 10–32 x 5/8 set screw.
5. Attach the support rod to the tube with the 8–32 x 3/8 thumbscrew.

Probe Stand Operation

The support rod is marked with sensor positions that correspond to each probe, and the probe stand tube is graduated to easily measure the distance to the floor.

The base plate includes:

- **Handholds (2)**—To easily move the probe stand
- **Floor grid finders (2)**—To align probe to floor grid

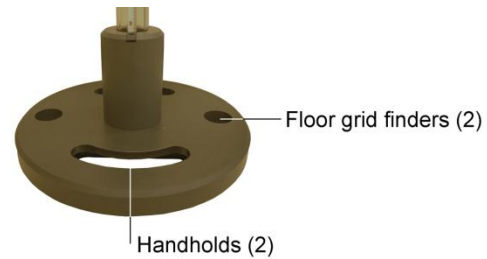

1. Attach the probe to the probe carrier using the probe thumbscrew.

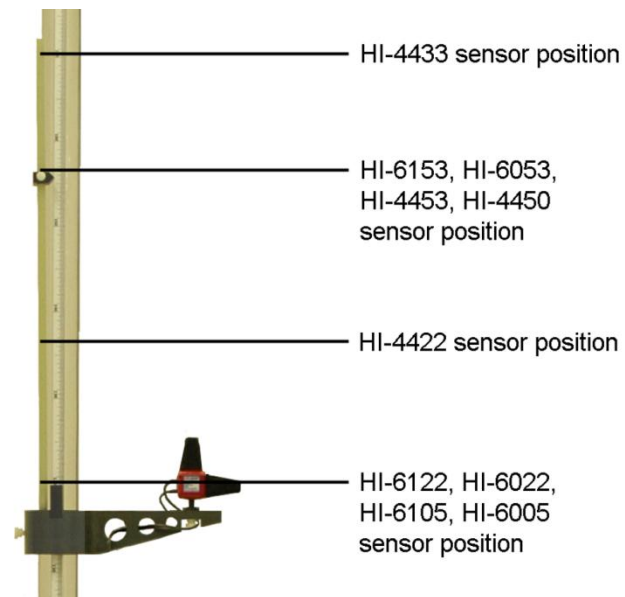

2. Align the scale pointer to the mark for the probe you are using, and confirm the distance is between the estimated minimum and maximum provided in the following *Estimated Distance from Element to Floor* chart.

Field Probe	Minimum	Maximum
HI-4433	800 mm (31.5 in)	2438 mm (96 in)
HI-6153 HI-6053 HI-4453 HI-4450	673 mm (26.5 in)	2438 mm (96 in)
HI-4422	317.5 mm (12.5 in)	2438 mm (96 in)
HI-6122 HI-6022 HI-6105 HI-6005	292 mm (11.5 in)	2438 mm (96 in)

Estimated Distance from Element to Floor

This page intentionally left blank.

7.0 Probe Shield Care and Replacement

If you have an HI-6122, HI-6022, HI-6105, or HI-6005 Field Probe, over time the probe shields (the cone-shaped structures with axis labels) may accumulate foreign materials that could become embedded in the shield surface. Probe shields must be kept clean to maintain proper operation.

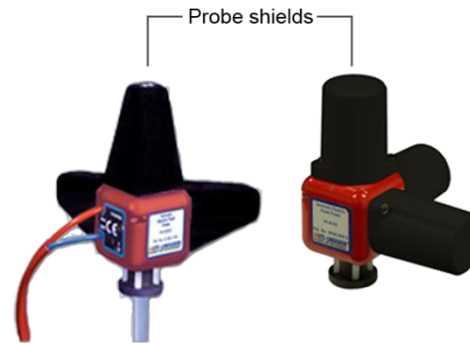

If the probe shields need to be replaced, you may order them from ETS-Lindgren. Follow these steps to replace the probe shields:

1. Remove the nylon screws from the probe shield.
2. Lift the shield straight up and away from the housing.
 - ➔ Lift the shield high enough to clear the internal antenna assembly, or you may damage the assembly. Never touch the antenna assembly. You may transfer a static charge to the assembly that may distort or disable the measuring capability in that axis.
3. With the probe in a protective, supportive position, carefully replace the probe shield by lowering it straight down onto the housing.
 - ➔ Make sure to clear the internal antenna assembly when lowering the shield or you may damage the assembly.

4. Replace the screws snugly without over-tightening them.



Over-tightening the screws may damage the screw heads. If you require additional nylon screws, you may order them from ETS-Lindgren or obtain them locally. Non-conductive screws must be used for this application. Never use metal screws.

5. Repeat this procedure for the other shields, if necessary.

Appendix A: Warranty



See the *Product Information Bulletin* included with your shipment for the complete ETS-Lindgren warranty for your EMC Field Probe.

DURATION OF WARRANTIES

All product warranties, except the warranty of title, and all remedies for warranty failures are limited to three years.

Product Warranted	Duration of Warranty Period
HI-6005	3 Years
HI-6022	3 Years
HI-6053	3 Years
HI-6105	3 Years
HI-6122	3 Years
HI-6153	3 Years

This page intentionally left blank.

Appendix B: Series H-491198-01 Battery Charger for NiMH Batteries



The HI-6053 Field Probe contains four AAA Nickel-Metal Hydride (NiMH) batteries, and uses the Series H-491198-01 Battery Charger.

SAFETY PRECAUTIONS

CAUTION

Before operating the Series H-491198-01 Battery Charger, see *General Safety Considerations* on page ix.

INTRODUCTION

The **H-491198-01 Nickel-Metal Hydride (NiMH) Battery Charger** is a dual power source battery charger. It charges 4.8 volt 220 mA NiMH batteries and is powered by 85-264 VAC line power or 12.5 VDC. The H-491198-01 Battery Charger uses a $-(dV)/(dT)$ negative delta V technique to determine when the battery is fully charged, which is typically two hours. With this technique, the charge state of the battery has no effect other than shortening the charge time.



Housed in a rugged enclosure, power enters the battery charger through a power entry module, which contains the fuses, or an optional cigarette lighter plug adapter. The front face of the battery charger displays LEDs that provide the operating status. The battery charger connects to the device being charged through a short cord terminated with a power jack.

An integrated circuit within the battery charger monitors the battery voltage and controls the charging functions according to the charge state of the battery.

BATTERY LIFE

The NiMH batteries powering the battery-operated probe have high energy density for maximum operating time between charges, but also have a significant self-discharge characteristic. When the probe is stored for longer than a week or two, the batteries will discharge even though not in use. Leaving the batteries in a discharged condition for long periods of time may result in reduced battery life. For optimum testing time, charge the batteries before use.

The battery charger is microprocessor controlled to charge the batteries in the fastest possible manner. When the charger senses that the batteries are fully charged, the charging current drops to a maintenance level. This level is sufficient to maintain the full charged without causing battery damage. It is acceptable to leave the probe connected to the battery charger for extended periods of time.

With proper care, the batteries should last two to three years. Follow these recommendations to ensure maximum battery life and optimum testing performance:

- Turn the probe off when the probe is not in use. Leaving the probe on for extended periods of time will damage the batteries. When the batteries are discharged, the flashing power **ON** indicator will not function.
- When possible, leave the probe connected to the battery charger, and the battery charger connected to the mains electrical supply (charger operating). The battery charger status indicators will show **CHARGER ON** and **COMPLETE** when the batteries are on a maintenance charge.
- Operate the probe only within the optimum operating temperature range of +20°C to +30°C (+68°F to +86°F). Although NiMH batteries are rated for operation in temperatures from -20°C to +65°C (-4°F to +140°F), operating the probe at temperature extremes reduces the operating time of the batteries.
- Make sure the batteries are fully charged before resuming operation. The batteries do not require periodic deep discharges to reverse the effect caused by repeated shallow discharges, but undercharging can reduce battery capacity.

Fully charged batteries (nominal output voltage of 4.8 VDC) provide up to 30 hours of operation. When the batteries have discharged to 4.4 VDC, the probe will operate, but the batteries need to be charged. When the voltage drops below 4.0 VDC, measurement accuracy may be compromised by continued operation. When the battery voltage indication is less than 4 volts, a low battery indication is attached to the output data string warning of the problem. ETS-Lindgren software applications provide a warning indication on the display screen of the readout device. It is recommended that custom software packages using data from the probe monitor the data output for this condition.

If the batteries exhibit low terminal voltages during charging, or if they appear unable to acquire or maintain a charge, the batteries may be shorted or damaged. To replace the batteries, see *HI-6053 Battery Replacement* on page 62.

CHARGING THE BATTERIES

For maximum battery life, fully charge the batteries before placing the probe into service. Failing to fully charge the batteries may result in reduced battery life and cause premature battery failure.

To charge a battery:

1. Make sure the probe is off or the batteries will not charge.
2. Connect the battery charger to the electrical mains, and then plug the charger output into the battery charger connector on the probe.

CAUTION

Never attempt to recharge a non-rechargeable battery.

CHARGING INDICATORS

The following LEDs are located on the front of the battery charger:

- **POWER ON** (green)—Indicates the battery charger is connected to the AC power source.

- **NO BATTERY** (amber)—Indicates the battery charger does not detect a battery.

- **PENDING** (amber)—Indicates the battery charger detects a battery.

Before fast charging can begin, the battery voltage must fall within predetermined acceptable limits. A pulse-trickle charge is provided to bring a depleted battery to a valid charge prior to fast charge.

- **CHARGING** (amber)—Indicates the voltage pre-qualification condition has been met, and fast charge has started.

Fast charging continues until termination by a peak voltage detect or a maximum charge time. For peak voltage detect, the fast charge is terminated when the battery voltage is lower than the previously measured values by 24mV. If a peak voltage is not detected, then the fast charge is terminated when the maximum time limit of 180 minutes is reached.

- **COMPLETE** (green)—Indicates a fast charging peak voltage is detected.

If the probe is turned on during the fast charge period of the charge cycle, the current surge that the batteries provide to the electronics in the probe will cause a momentary voltage drop on the batteries, causing the charger to terminate the fast charge based on a peak voltage detect condition.

The battery charger switches to top-off charge mode that provides a charge current one-eighth of the fast charge rate. This charge continues from the time when a peak voltage detect terminates the fast charge, until the maximum time of 180 minutes is reached. If the probe is disconnected from the charger at this point in the charge cycle, the batteries will operate properly.

Following the maximum time of 180 minutes, a pulse-trickle charge mode is used to compensate for the self-discharge of the batteries while idle in the charger.

The fast charge current is low enough that there is not always enough heating of the battery cells to cause the voltage to drop. With no voltage drop there is no peak voltage detection, and the fast charge will terminate after the maximum time of 180 minutes is reached.

SYNCHRONIZING THE BATTERY CHARGE INDICATOR

The probe has internal circuitry to track the charge condition of the batteries. NiMH batteries have a sharp discharge-curve knee, which means there is little indication that the batteries are nearly discharged prior to a low battery condition. The internal circuitry tracks the charging and discharging currents of the batteries and displays the calculated battery condition.

It is possible that the battery charge indication may lose synchronization with the actual battery condition. A loss of synchronization may be indicated by a low battery charge alert after the batteries were recently fully charged. Loss of synchronization may also be indicated by short battery life and premature low battery alert.

To synchronize the battery charge indicator:

1. Make sure the probe is off or the batteries will not charge.
2. Connect the battery charger to the electrical mains, and then plug the charger output into the battery charger connector on the probe.
3. Press the **DISCHARGE** button on the battery charger. The batteries will fully discharge, and then fully recharge. The total time required to discharge and recharge is approximately seven hours.
4. For best results, repeat the process once. However, it may be necessary to repeat the process three times for proper synchronization. The synchronization process may take up to 12 hours.

When completely charged, the battery indicator for the probe should indicate a charge level of more than 90%.

DISCHARGING A BATTERY

To discharge the batteries:

1. Make sure the probe is off or the batteries will not charge.
2. Connect the battery charger to the electrical mains, and then plug the charger output into the battery charger connector on the probe.
3. Press the **DISCHARGE** button on the battery charger. The batteries will fully discharge, and then fully recharge. The total time required to discharge and recharge is approximately seven hours.

SPECIFICATIONS

BATTERY CHARGER SPECIFICATIONS

The battery charger may be powered by standard line voltage (110–240 VAC, 50–60 Hz) or by an optional automobile cigarette lighter plug (12.5 VDC).

NiMH Battery:	<ul style="list-style-type: none">• 4 AAA batteries, rechargeable NiMH (rapid charge cells, 1.2 volts/cell)• ETS-Lindgren Part #400038 (quantity required = 4)
Power	
Main:	IEC filtered AC power input module 110-240 VAC, 500 mA max, 50-100 Hz
Alternate:	Automobile cigarette lighter to 2 mm power plug adapter cord, 12.5 Vdc, 100 mA
Fuses:	250 volt, 1.0 Amp, Type T (5 mm x 20 mm)

Output	
Open Circuit Voltage:	12 Vdc
Fast Charge Pending Current:	2.0 mA
Fast Charge Current:	220 mA
Pulsed Trickle Charge Current:	2.0 mA
Output Voltage (During Fast Charge):	4–8 Vdc
Environmental	
Operating Temperature:	10°C to 40°C 50°F to 104°F
Humidity:	5% to 95% relative humidity, non-condensing

MAINTENANCE RECOMMENDATIONS

- Operate the battery charger with care.
- There are no user serviceable parts inside the battery charger. Opening the battery charger housing may void your warranty.

REPLACING THE FUSE

CAUTION

Disconnect the battery charger from power before replacing a fuse.

If the battery charger fails to operate, check for a blown fuse inside the power entry module. A blown fuse must be replaced with the same value and type of fuse, or an unsafe condition may result. Use only 250 Volt, 1.0 Amp, Type T (5 mm x 20 mm) fuses.

To replace a fuse:

1. Two fuses are located in the fuse drawer in the power input module. Use a screwdriver to open the drawer.
2. The fuse towards the outside of the drawer is the spare. Remove the spare fuse from the module.

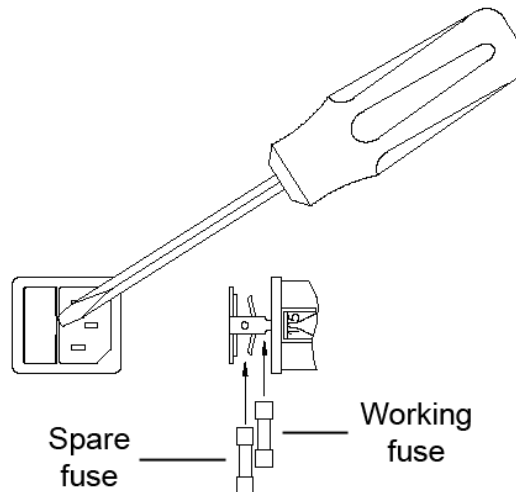

3. Replace the blown fuse with the spare fuse.
4. Slide the fuse drawer back into the module. Make sure that the drawer snaps securely into its locked position.

Appendix C: Series H-491198-48 Battery Charger for NiMH Batteries



The HI-6022 and HI-6005 probes contain a Nickel-Metal Hydride (NiMH) battery, and use the Series H-491198-48 Battery Charger.

SAFETY PRECAUTIONS

CAUTION

Before operating the Series H-491198-48 Battery Charger, see *General Safety Considerations* on page ix.

INTRODUCTION

The **H-491198-48 Nickel-Metal Hydride (NiMH) Battery Charger** is a dual power source battery charger. It charges 4.8 volt 25 mA NiMH batteries and is powered by 85-264 VAC line power or 12.5 VDC. The H-491198-48 Battery Charger uses a $-(dV)/(dT)$ negative delta V technique to determine when the battery is fully charged, which is typically two hours. With this technique, the charge state of the battery has no effect other than shortening the charge time.

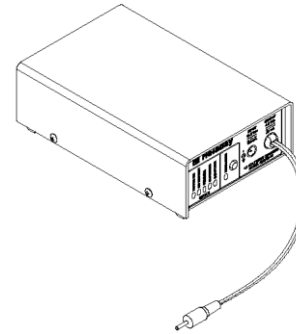

Housed in a rugged enclosure, power enters the battery charger through a power entry module, which contains the fuses, or an optional cigarette lighter plug adapter. The front face of the battery charger displays LEDs that provide the operating status. The battery charger connects to the device being charged through a short cord terminated with a power jack.

An integrated circuit within the battery charger monitors the battery voltage and controls the charging functions according to the charge state of the battery.

BATTERY LIFE

The NiMH battery powering the battery-operated probe has high energy density for maximum operating time between charges, but also has a significant self-discharge characteristic. When the probe is stored for longer than a week or two, the battery will discharge even though not in use. Leaving the battery in a discharged condition for long periods of time may result in reduced battery life. For optimum testing time, charge the battery before use.

The battery charger is microprocessor controlled to charge the battery in the fastest possible manner. When the charger senses that the battery is fully charged, the charging current drops to a maintenance level. This level is sufficient to maintain the battery fully charged without causing battery damage. It is acceptable to leave the probe connected to the battery charger for extended periods of time.

With proper care, the battery should last two to three years. Follow these recommendations to ensure maximum battery life and optimum testing performance:

- Set the power switch on the probe to the **OFF** position when the probe is not in use. Leaving the power switch in the **ON** position for extended periods of time will damage the battery. When the battery is discharged, the flashing power **ON** indicator will not function.
- When possible, leave the probe connected to the battery charger, and the battery charger connected to the mains electrical supply (charger operating). The battery charger status indicators will show **CHARGER ON** and **COMPLETE** when the battery is on a maintenance charge.
- Operate the probe only within the optimum operating temperature range of +20°C to +30°C (+68°F to +86°F). Although NiMH batteries are rated for operation in temperatures from -20°C to +65°C (-4°F to +140°F), operating the probe at temperature extremes reduces the operating time of the batteries.
- Make sure the battery is fully charged before resuming operation. The battery does not require periodic deep discharges to reverse the effect caused by repeated shallow discharges, but undercharging can reduce battery capacity.

A fully charged battery (nominal output voltage of 4.8 VDC) provides up to 10 hours of operation. When the battery has discharged to 4.4 VDC, the probe will operate, but the battery will need to be charged. When the voltage drops below 4.0 VDC, measurement accuracy may be compromised by continued operation. When the battery voltage indication is less than four volts, a low battery indication is attached to the output data string warning of the problem. ETS-Lindgren software applications provide a warning indication on the display screen of the readout device. It is recommended that custom software packages using data from the probe monitor the data output for this condition.

If the battery exhibits low terminal voltages during charging, or if it appears unable to acquire or maintain a charge, individual cells in the battery may be shorted or damaged. If your battery needs replacement for any reason, contact ETS-Lindgren Customer Service.

CHARGING A BATTERY

For maximum battery life, fully charge the battery for the probe before placing the probe into service. Failing to fully charge the battery may result in reduced battery life and cause premature battery failure.

To charge a battery:

1. Make sure the power switch on the probe is set to the **OFF** position or the battery will not charge.
2. Connect the battery charger to the electrical mains, and then connect the charger output to the charger jack on the probe.

CAUTION

Never attempt to recharge a non-rechargeable battery.

CHARGING INDICATORS

The following LEDs are located on the front of the battery charger:

- **POWER ON** (green)—Indicates the battery charger is connected to the AC power source.

- **NO BATTERY** (amber)—Indicates the battery charger does not detect a battery.

- **PENDING** (amber)—Indicates the battery charger detects a battery.

Before fast charging can begin, the battery voltage must fall within predetermined acceptable limits. A pulse-trickle charge is provided to bring a depleted battery to a valid charge prior to fast charge.

- **CHARGING** (amber)—Indicates the voltage pre-qualification condition has been met, and fast charge has started.

Fast charging continues until termination by a peak voltage detect or a maximum charge time. For peak voltage detect, the fast charge is terminated when the battery voltage is lower than the previously measured values by 24mV. If a peak voltage is not detected, then the fast charge is terminated when the maximum time limit of 180 minutes is reached.

- **COMPLETE** (green)—Indicates a fast charging peak voltage is detected.

If the probe is turned on during the fast charge period of the charge cycle, the current surge that the battery provides to the electronics in the probe will cause a momentary voltage drop on the battery, causing the charger to terminate the fast charge based on a peak voltage detect condition.

The battery charger switches to top-off charge mode that provides a charge current one-eighth of the fast charge rate. This charge continues from the time when a peak voltage detect terminates the fast charge, until the maximum time of 180 minutes is reached. If the probe is disconnected from the charger at this point in the charge cycle, the battery will operate properly.

Following the maximum time of 180 minutes, a pulse-trickle charge mode is used to compensate for the self-discharge of the battery while idle in the charger.

The batteries are small, and the fast charge current is low. The fast charge current is low enough that there is not always enough heating of the battery cells to cause the voltage to drop. With no voltage drop there is no peak voltage detection, and the fast charge will terminate after the maximum time of 180 minutes is reached.

SYNCHRONIZING THE BATTERY CHARGE INDICATOR

The probe has internal circuitry to track the charge condition of the battery. NiMH batteries have a sharp discharge-curve knee, which means there is little indication that the battery is nearly discharged prior to a low battery condition. The internal circuitry tracks the charging and discharging currents of the battery and displays the calculated battery condition.

It is possible that the battery charge indication may lose synchronization with the actual battery condition. A loss of synchronization may be indicated by a low battery charge alert after the battery was recently fully charged. Loss of synchronization may also be indicated by short battery life and premature low battery alert.

To synchronize the battery charge indicator:

1. Make sure the power switch on the probe is set to the **OFF** position or the battery will not charge.
2. Connect the battery charger to the electrical mains, and then connect the charger output to the charger jack on the probe.
3. Press the **DISCHARGE** button on the battery charger. The battery will fully discharge, and then fully recharge. The total time required to discharge and recharge is approximately seven hours.
4. For best results, repeat the process once. However, it may be necessary to repeat the process three times for proper synchronization. The synchronization process may take up to 12 hours.

When completely charged, the battery indicator for the probe should indicate a charge level of more than 90%.

DISCHARGING A BATTERY

To discharge a battery:

1. Make sure the power switch on the probe is set to the **OFF** position or the battery will not charge.
2. Connect the battery charger to the electrical mains, and then connect the charger output to the charger jack on the probe.
3. Press the **DISCHARGE** button on the battery charger. The battery will fully discharge, and then fully recharge. The total time required to discharge and recharge is approximately seven hours.

SPECIFICATIONS

BATTERY CHARGER SPECIFICATIONS

The battery charger may be powered by standard line voltage (110–240 VAC, 50–60 Hz) or by an optional automobile cigarette lighter plug (12.5 VDC).

NiMH Battery:	<ul style="list-style-type: none">• 4.8 volt 4 cell NiMH Battery, 25 mAH (rapid charge cells, 1.2 volts/cell)• ETS-Lindgren Part #H-491193
Power	
Main:	IEC filtered AC power input module 110-240 VAC, 500 mA max, 50-100 Hz
Alternate:	Automobile cigarette lighter to 2 mm power plug adapter cord, 12.5 Vdc, 100 mA
Fuses:	250 volt, 1.0 Amp, Type T (5 mm x 20 mm)

Output	
Open Circuit Voltage:	12 Vdc
Fast Charge Pending Current:	2.0 mA
Fast Charge Current:	25 mA
Pulsed Trickle Charge Current:	2.0 mA
Output Voltage (During Fast Charge):	4–8 Vdc
Environmental	
Operating Temperature:	10°C to 40°C 50°F to 104°F
Humidity:	5% to 95% relative humidity, non-condensing

MAINTENANCE RECOMMENDATIONS

- Operate the battery charger with care.
- There are no user serviceable parts inside the battery charger. Opening the battery charger housing may void your warranty.

REPLACING THE FUSE

CAUTION

Disconnect the battery charger from power before replacing a fuse.

If the battery charger fails to operate, check for a blown fuse inside the power entry module. A blown fuse must be replaced with the same value and type of fuse, or an unsafe condition may result. Use only 250 Volt, 1.0 Amp, Type T (5 mm x 20 mm) fuses.

To replace a fuse:

1. Two fuses are located in the fuse drawer in the power input module. Use a screwdriver to open the drawer.
2. The fuse towards the outside of the drawer is the spare. Remove the spare fuse from the module.

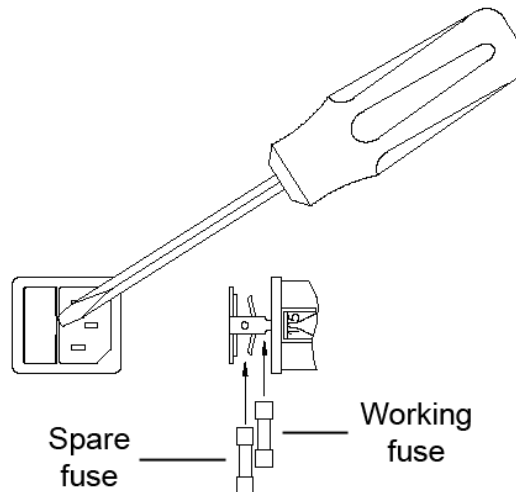

3. Replace the blown fuse with the spare fuse.
4. Slide the fuse drawer back into the module. Make sure that the drawer snaps securely into its locked position.

Appendix D: Operating Protocols



The information in this section is subject to change, and is included for reference only. ETS-Lindgren recommends that you use the commands and information provided in *ETSProbe DLL User Guide* on page 111.

The following information assumes that the HI-6113 Laser Data Interface (LDI), HI-4413P Fiber Optic Modem, or HI-4413USB Fiber Optic to USB Converter was purchased and is communicating directly with the probe.

COMMUNICATION PROTOCOL

HI-61XX SERIES LASERPRO FIELD PROBES

Data Type:	RS-232 Serial
Data Mode:	Asynchronous
Word Length:	8 bit
Parity:	N
Stop Bits:	1
Data Rate:	115,200 baud

HI-60XX SERIES BATTERY-OPERATED FIELD PROBES

Data Type:	RS-232 Serial
Data Mode:	Asynchronous
Word Length:	7bit
Parity:	Odd
Stop Bits:	1
Data Rate:	9600 baud

INFORMATION TRANSFER PROTOCOL

The probe responds to commands from another device; it transmits no data without first receiving instructions to do so.

COMMAND STRUCTURE

See the following pages for detailed information regarding the command structure to the probe. When the probe completes the command, it responds with a string consisting of:

- A start character (":")
- The command letter
- Data (if required)
- <CR> (a carriage return)

If the command does not require the probe to return any data, the probe simply responds with the start character (":") then the command letter and a carriage return. If an error occurs, the probe responds with an error code.

PROBE COMMANDS

All probe commands return :E7 when the probe is turned off.

HI-61XX SERIES LASERPRO FIELD PROBES

Probe Command	Description	Probe Response
B<CR>	Read probe converter voltage	:Bxx.xx<CR>

Probe Command	Description	Probe Response
BP	Read probe converter voltage in hexadecimal format	:B64N <ul style="list-style-type: none"> • N=safe operating level • F=fail level Voltage reported as 0–64; 64 corresponds to 100%



The **BP** command is provided for backward compatibility and should not be used to monitor the converter voltage, which always responds with :B64N<CR>.

Probe Command	Description	Probe Response
D3	Read probe data	:Dx.xxxxyy.yyzzz.zB<CR> <ul style="list-style-type: none"> • xxxx, yyyy, zzzz= 4-digit axis values with floating decimal point • B=battery flag, N or F
D5	Read probe data	:Dx.xxxxyy.yyzzz.zcccc.B<CR> <ul style="list-style-type: none"> • xxxx, yyyy, zzzz= 4-digit axis values with floating decimal point • cccc=composite field value with floating decimal point • B=battery flag, N or F

Probe Command	Description	Probe Response
I	Identification command	:I61XX<sr><sn><cd>B<CR> <ul style="list-style-type: none"> • XX=specific probe model • sr=10-character software revision • sn=8-character serial number • cd=8-character calibration date • B=battery flag, N or F



The Identification command, I, may also be used as the first command sent. The command will turn on the laser. Once communication between the probe and the Laser Data Interface (LDI) is established, the return string will be sent. Subsequent I commands immediately send the return string.

Probe Command	Description	Probe Response
TC	Read temperature in Centigrade	:Txxx.<CR>
TF	Read temperature in Fahrenheit	:Txxx.<CR>
<Null><CR>	Send the ASCII null character	:N<CR>



<Null><CR> is a special command that can be used as the initial command to the probe **after** it is turned on.

HI-60XX SERIES FIELD PROBES

Probe Command	Description	Probe Response
B<CR>	Read battery voltage	<p><i>:Bxx.xx<CR></i></p> <ul style="list-style-type: none"> • <i>:B04.80</i> =100% of charge =4.8 volts • <i>:B04.00</i> =0% of charge =4.0 volts
BP	Read battery capacity in percentage	<p><i>Bxx<N or F><CR></i></p> <ul style="list-style-type: none"> • <i>:B64N</i> =100% of charge =4.8 volts • <i>:B00F</i> =0% of charge =4.0 volts • <i>N</i>=safe operating level • <i>F</i>=fail level <p>Percentage reported in hexadecimal, 0% to 64%</p>



The **BP** command is provided for backward compatibility and should not be used to monitor the converter voltage, which always responds with *:B64N<CR>*.

Probe Command	Description	Probe Response
D3	Read probe data	:Dx.xxyy.yyzz.zB<CR> <ul style="list-style-type: none"> • xxx, yyyy, zzzz= 4-digit axis values with floating decimal point • B=battery flag, N or F
D5	Read probe data	:Dx.xxyy.yyzz.zcccc.B<CR> <ul style="list-style-type: none"> • xxx, yyyy, zzzz= 4-digit axis values with floating decimal point • cccc=composite field value with floating decimal point • B=battery flag, N or F
I	Identification command	:I60XX<sr><sn><cd>B<CR> <ul style="list-style-type: none"> • XX=specific probe model • sr=10-character software revision • sn=8-character serial number • cd=8-character calibration date • B=battery flag, N or F



The Identification command, I, may also be used as the first command sent. The command will turn on the laser. Once communication between the probe and the Laser Data Interface (LDI) is established, the return string will be sent. Subsequent I commands immediately send the return string.

TC	Read temperature in Centigrade	:Txxx.<CR>
----	--------------------------------	------------

Probe Command	Description	Probe Response
TF	Read temperature in Fahrenheit	:Txxx.<CR>
<Null><CR>	Send the ASCII null character	:N<CR>



<Null><CR> is a special command that can be used as the initial command to the probe **after** it is turned on.

HI-6113 LASER DATA INTERFACE COMMANDS

LDI Command	Description	Probe Response
i	Laser data interface identification string	:i6113<sr><sn><CR> <ul style="list-style-type: none"> • sr=10-character software revision • sn=8-character serial number
n	Read laser current	:nx.xxx.<CR>
o	Laser OFF command	:o The laser and all LEDs except the green Power LED will turn off
r	Laser ON command	:r The blue Laser LED will illuminate immediately, then the yellow Receive LED will illuminate a few seconds after, indicating the probe is ready for operation

LDI Command	Description	Probe Response
-------------	-------------	----------------



The Laser ON command, r, should be the first command sent.

LDI Command	Description	Probe Response
tc	Read temperature in Centigrade	:txxx.<CR>
tf	Read temperature in Fahrenheit	:txxx.<CR>

PROBE ERROR OUTPUT

If an error occurs, the probe will respond with one of the following strings. These strings begin with a colon and end with a carriage return.

- E1 Communication error (for example, overflow)
- E2 Buffer full error; too many characters contained between the start character and carriage return sequence
- E3 Received command is invalid
- E4 Received parameter is invalid
- E5 Hardware error (for example, EEPROM failure)
- E6 Parity error
- E7 Probe commands are not available unless the probe is powered on. To power on the probe, send the Laser ON command, `r`. For more information on the `r` command, see page 107.
- E9 Received command is invalid

This page intentionally left blank.

Appendix E: ETSProbe DLL User Guide

The **ETS-Lindgren ETSProbe DLL** allows users to communicate with one or more supported ETS-Lindgren field probes. The main deliverable consists of a Microsoft® Windows® Dynamic Link Library (DLL) that can be called by a wide variety of programming languages.

ETSProbe DLL is intended for users who want to integrate ETS-Lindgren probes into their own software system.

About Redistribution

Redistribution and use in source and binary forms, with or without modification, are permitted provided the following conditions are met:

- Redistributions of source code must retain the ETS-Lindgren copyright notice, this list of conditions, and the following disclaimer.
- Redistributions in binary form must reproduce the ETS-Lindgren copyright notice, this list of conditions, and the following disclaimer in the documentation and/or other materials provided with the distribution.

(Disclaimer) Neither the name ETS-Lindgren nor the names of its contributors may be used to endorse or promote products derived from this software without specific prior written permission.

Getting Started

1. Download ETSProbe DLL from www.ets-lindgren.com.
2. Install ETSProbe DLL using the included automatic installer.

During installation (provided the installation path is not altered), an assortment of example programs in various languages will be copied to C:\Program Files\ETS-Lindgren\ETSProbe DLL\examples.
3. Create your new program or adapt your existing program to interface with ETSProbe DLL.

DLL Function Calling Conventions

1. The function call stack/style is the WinAPI style. This allows the widest variety of users to be able to call these functions.
2. The functions take and return only basic types of arguments (32 bit integer, floating point values, and simple c-style zero terminated strings).
3. All outbound string parameters are allocated by the caller and are followed in the argument list by a maximum string length integer parameter.
4. For the same reason, the functions do not take in or send out any object style parameters.
5. All functions have an integer return value such that 0 will signify successful completion. All other values that can be returned are function-specific.

Supported Probes and Communications Protocols

Probe families HI-Any and FP-Any are probe-type detectors. These detector-probe types can be used in most cases without specifying the exact probe family. There are a few other families that offer higher data sample rates. By default all probes are put into auto range. The following table lists the probe families that can be used with each probe model.

	Model	Family Strings
1	FP1000	FP-Any HI-44xx MS
2	FP2000	FP-Any
3	FP2031	FP-Any
4	FP2033	FP-Any
5	FP2036	FP-Any
6	FP2080	FP-Any

	Model	Family Strings
7	FP2083	FP-Any
8	FP2103	FP-Any
9	FP2130	FP-Any
10	FP3000A	
11	FP3001	
12	FP3080A	
13	FP3083	
14	FP4000	FP-Any HI-44xx MS
15	FP4031	FP-Any HI-44xx MS
16	FP4033	FP-Any HI-44xx MS
17	FP4080	FP-Any HI-44xx MS
18	FP4083	FP-Any HI-44xx MS
19	FP4240	FP-Any HI-44xx MS
20	FP5000	FP-Any HI-44xx MS
21	FP5033	FP-Any HI-44xx MS
22	FP5034	FP-Any HI-44xx MS
23	FP5036	FP-Any HI-44xx MS
24	FP5080	FP-Any HI-44xx MS
25	FP5083	FP-Any HI-44xx MS
26	FP5240	FP-Any HI-44xx MS

	Model	Family Strings
27	FP6001	FP-Any HI-44xx MS
28	HI-2200 C300	
29	HI-2200 C310	
30	HI-2200 E100	
31	HI-2200 H200	
32	HI-2200 H210	
33	HI-3603	
34	HI-3604	
35	HI-3638	HI-Any HI-44xx MS
36	HI-3702	HI-Any HI-44xx MS
37	HI-4417	
38	HI-4421	HI-Any HI-44xx MS
39	HI-4421G	HI-Any HI-44xx MS
40	HI-4422	HI-Any HI-44xx MS
41	HI-4431-HCH	HI-Any HI-44xx MS
42	HI-4431-HSE	HI-Any HI-44xx MS
43	HI-4431-MSE	HI-Any HI-44xx MS
44	HI-4431-STE	HI-Any HI-44xx MS
45	HI-4433-CH	HI-Any HI-44xx MS
46	HI-4433-GRE	HI-Any HI-44xx MS

	Model	Family Strings
47	HI-4433-HCH	HI-Any HI-44xx MS
48	HI-4433-HSE	HI-Any HI-44xx MS
49	HI-4433-LFH	HI-Any HI-44xx MS
50	HI-4433-STE	HI-Any HI-44xx MS
51	HI-4450	HI-Any HI-44xx MS
52	HI-4451	HI-Any HI-44xx MS
53	HI-6005	HI-Any HI-6005 MS HI-6005 HS HI-6005
54	HI-6022	HI-Any HI-6005 MS HI-6005 HS HI-6005
55	HI-6053	HI-Any HI-6005 MS HI-6005 HS HI-6005
56	HI-6105	HI-Any Laser HS Laser
57	HI-6153	HI-Any Laser HS Laser

PROBE FAMILY HI-ANY (AUTO PROBE DETECTOR)

Automatically detects most ETS-Lindgren Holaday probes, as listed in the following:



Baud rates are at 9600 and 115.2 K for the laser models.

- FP5000 Series
- FP4000 Series
- HI-6000 Series
- HI-6100 Series
- HI-4433 Series
- HI-4450 Series

PROBE FAMILY FP-ANY (AUTO PROBE DETECTOR FP)

Automatically detects most ETS-Lindgren Holaday probes, as listed in the following:



Use this type to initialize all FP-series probes.

- FP2000 Series
- FP4000 Series
- FP5000 Series
- FP6001

PROBE FAMILY VIRTUAL

This simulated probe type is for testing and software development purposes. Varying field values are generated using a *sin* function.

PROBE FAMILY HI-44xx MS

Use this type to obtain higher sample rates on 3-axis probes. This type does not return individual field readings for each axis.

FP5080	HI-4450	FP4080
FP5000	FP5240	FP4083
FP5033	HI-4451	FP4240
FP5034	HI-4453	HI-4422
FP5036	HI-4455	HI-4433-GRE
FP5055	HI-4456	HI-4433-HSE
FP5083	HI-4457	HI-4433-MSE
FP4031	FP4000	HI-4433-STE

PROBE FAMILY HI-6005 MS (MEDIUM SPEED)



Baud rate at 9600. Sample rates exceed 30 samples/second.

- FP6001
- HI-6005
- HI-6053

PROBE FAMILY HI-6005 HS (HIGH SPEED)



Baud rate at 19200. Sample rates exceed 50 samples/second.

- FP6001
- HI-6005
- HI-6053

PROBE FAMILY LASER HS (HIGH SPEED)



Baud rate at 115200. Laser-powered probes through USB port.
Sample rate can exceed 100 samples/second.

- HI-6105
- HI-6153

PROBE TYPES NOT SUPPORTED

- HI-3603
- HI-3604
- HI-2200

Quick Start Function Reference

ETS_CREATEPROBE()

```
int ETS_CreateProbe(const char *name, int &Handle, const char
*CommSettings, const char *Family);
```

- Purpose:** Creates a probe object and establishes communications to a specified probe.
- Makes an object of the correct type.
 - Verifies that the communications to the probe can be established.
 - Does a probe identify and an initialization of the probe.
- Return Value:** Returns an integer status code. The numeric value **0** indicates successful completion.
See *Status Codes* on page 121 for error code description.

Input Parameters:

Case sensitive strings must be used.

char CommSettings

```
ASRL1::INSTR /Comm Port 1  
Com1  
Com2  
etc.
```

char Family

```
HI-Any  
FP-Any  
HI-44xx MS  
HI-6005 MS  
HI-6005 HS  
Laser HS  
Virtual
```

In most cases HI-Any and FP-Any will communicate with both HI and FP models. The exception is that HI-Any must be used to communicate with laser probe models and FP-Any must be used with the FP2000-Series probe models.

Use HS types High Speed for higher sample rates. The HI-44xx HS family does not return individual data from each axis, but does increase the sample rate.

char name

```
Any user specified name  
myProbe  
Etc.
```

Output Parameters: `int * Handle`
Special value used to refer to this probe for subsequent function calls after it is created.

Returns: Returns an integer status code. The numeric value **0** indicates successful completion.
See *Status Codes* on page 121 for error code description.

ETS_READFIELDSYNCHRONOUS()

```
int ETS_ReadFieldSynchronous(int Handle, float &XField, float  
&YField, float &ZField, float &XYZField);
```

Purpose: Takes a single field reading of all axes. The function does not return until all data is captured and processed. Ranging is handled automatically provided **ETS_Range** has not been set.

Return Value: Returns an integer status code. The numeric value **0** indicates successful completion.
See *Status Codes* on page 121 for error code description.

Input Parameters: `int probeHandle`
As returned from **ETS_CreateProbe** function.

Output Parameters: Pass-by-reference float: The field values for the X, Y, Z, and combined axes.

ETS_REMOVEPROBE()

```
int ETS_RemoveProbe(const int probeHandle);
```

- Purpose:** Closes the communications port and releases memory back to the system.
The **ETS_RemoveProbe** function needs to be called whenever a probe is changed or physically removed.
- Return Value:** Returns an integer status code. The numeric value **0** indicates successful completion.
See *Status Codes* on page 121 for error code description.
- Input Parameters:** `int probeHandle`
As returned from **ETS_CreateProbe** function.
- Output Parameters:** None.

Advanced Function Reference

ETS_BATTERY()

```
int ETS_Battery(const int probeHandle, int &Batt);
```

- Purpose:** To obtain the battery status as a percentage of full charge. The **ETS_InitiateReadBattery** function must be called prior to this call. This function returns a fresh battery reading after each **ETS_InitiateReadBattery** command.
- Return Value:** Returns an integer status code. The numeric value **0** indicates successful completion.
See *Status Codes* on page 121 for error code description.
- Input Parameters:** `int probeHandle`
As returned from **ETS_CreateProbe** function.
- Output Parameters:** Pass-by-reference integer: The battery value as a percentage of full charge.

ETS_CALIBRATIONDATE()

```
int ETS_CalibrationDate(const int probeHandle, char  
*calibrationDate, const int arraySize);
```

- Purpose:**
- Returns the last calibration date for the probe.
 - Not available on older probes.
- Return Value:** Returns an integer status code. The numeric value **0** indicates successful completion.
See *Status Codes* on page 121 for error code description.
- Input Parameters:** `int probeHandle`
As returned from **ETS_CreateProbe** function.
- Output Parameters:** Pass-by-reference string:
`calibrationDate` specifying the length of string.

ETS_COMBINEDFIELD()

```
int ETS_CombinedField(const int probeHandle, float &XYZField);
```

- Purpose:** Returns the total combined field of the X, Y, and Z axes.
- Return Value:** Returns an integer status code. The numeric value **0** indicates successful completion.
See *Status Codes* on page 121 for error code description.
- Input Parameters:** int probeHandle
As returned from **ETS_CreateProbe** function.
- Output Parameters:** Pass-by-reference float: The combined fields of X, Y, and Z axes.

ETS_FIELD()

```
int ETS_Field(const int probeHandle, float &xField, float  
&yField, float &zField, float &combinedField);
```

Purpose: To read the field values from the X-axis, Y-axis, Z-axis, and the combined field. This function must follow an **ETS_InitiateReadField** command. You can poll **ETS_IsOperationComplete** to determine when **ETS_InitiateReadField** is finished.

Return Value: Returns an integer status code. The numeric value **0** indicates successful completion.
See *Status Codes* on page 121 for error code description.

Input Parameters: `int probeHandle`

Output Parameters: Pass-by-reference float: Returns the X, Y, Z, and combined field data.

ETS_FIRMWARE()

```
int ETS_Firmware(const int probeHandle, char *firmware, const  
int arraySize);
```

- Purpose:** To obtain the firmware version for the probe.
- Return Value:** Returns an integer status code. The numeric value **0** indicates successful completion.
See *Status Codes* on page 121 for error code description.
- Input Parameters:** int probeHandle
As returned from **ETS_CreateProbe** function.
- Output Parameters:** Pass-by-reference character string: Specifying the length of string.

ETS_GETERRORDESCRIPTION()

```
void ETS_GetErrorDescription(int errorNumber, char *ErrorStr,  
const int arraySize);
```

Purpose: To obtain a written description of an error that has occurred.

Return Value: None.

Input Parameters:

- `int probeHandle`
As returned from **ETS_CreateProbe** function.
- `int arraySize`

Output Parameters: Pass-by-reference character string: Specifying the length of string.

ETS_GETUNITSSTRING()

```
int ETS_GetUnitsString(const int probeHandle, char *UnitsStr,  
const int arraySize);
```

Purpose: To obtain the current field units setting for the probe.

Return Value: Returns an integer status code. The numeric value **0** indicates successful completion.
See *Status Codes* on page 121 for error code description.

Input Parameters:

- `int probeHandle`
As returned from **ETS_CreateProbe** function.
- `int arraySize`

Output Parameters: Pass-by-reference character string:
`UnitsStr` specifying the length of string.

ETS_INITIATEREADBATTERY()

```
int ETS_InitiateReadBattery(const int probeHandle);
```

Purpose: Initiates a reading of the battery as a percentage of full charge. The function returns immediately without waiting for the operation finish.

To determine when the command is finished, use **ETS_IsOperationComplete**. When the reading is complete, use **ETS_Battery** to obtain the value.

Return Value: Returns an integer status code. The numeric value **0** indicates successful completion.

See *Status Codes* on page 121 for error code description.

Input Parameters: `int probeHandle`

As returned from **ETS_CreateProbe** function.

Output Parameters: None.

ETS_INITIATEREADFIELD()

```
int ETS_InitiateReadField(const int probeHandle);
```

- Purpose:** Initiates a field reading from the probe. The function returns immediately without waiting for the operation finish.
- To determine when the operation is finished, use **ETS_IsOperationComplete**. When the reading is completed use **ETS_Field** or **ETS_CombinedField** to obtain the field values.
- The default field units are V/m or A/m.
- Return Value:** Returns an integer status code. The numeric value **0** indicates successful completion.
- See *Status Codes* on page 121 for error code description.
- Input Parameters:** int probeHandle
As returned from **ETS_CreateProbe** function.
- Output Parameters:** None.

ETS_INITIATEREADTEMPERATURE()

```
int ETS_InitiateReadTemperature(const int probeHandle);
```

Purpose: Initiates a reading of the internal temperature of the probe. The function returns immediately without waiting for the operation finish.

To determine when the operation is finished, use **ETS_IsOperationComplete**. When the reading is completed use **ETS_TemperatureC** to obtain the value.

Return Value: Returns an integer status code. The numeric value **0** indicates successful completion.

See *Status Codes* on page 121 for error code description.

Input Parameters: `int probeHandle`

As returned from **ETS_CreateProbe** function.

Output Parameters: None.

ETS_ISOPERATIONCOMPLETE()

```
int ETS_IsOperationComplete(const int probeHandle);
```

Purpose: Used with commands that start with the word **Initiate** to determine when an operation is finished.

Return Value: Returns an integer status code. The numeric value **0** indicates successful completion.
See *Status Codes* on page 121 for error code description.

Input Parameters: int probeHandle
As returned from **ETS_CreateProbe** function.

Output Parameters: None.

ETS_MODEL()

```
int ETS_Model(const int probeHandle, char *model, const int  
arraySize);
```

Purpose: Returns the probe model identification information.

Return Value: Returns an integer status code. The numeric value **0** indicates successful completion.
See *Status Codes* on page 121 for error code description.

Input Parameters: int probeHandle
As returned from **ETS_CreateProbe** function.

Output Parameters: The model name is placed in the user allocated string buffer.

ETS_PROBENAME()

```
int ETS_ProbeName(const int probeHandle, char *name, const int  
arraySize);
```

Purpose: Allows the user to read the user-assigned-name.

Return Value: Returns an integer status code. The numeric value **0** indicates successful completion.
See *Status Codes* on page 121 for error code description.

Input Parameters: int probeHandle
As returned from **ETS_CreateProbe** function.

Output Parameters: The probe name is placed in the user allocated string buffer.

ETS_READBATTERYSYNCHRONOUS()

```
int ETS_ReadBatterySynchronous(int Handle, int &battery);
```

Purpose: Reads the battery status of the probe and returns only after the probe has responded or a timeout has occurred.

Return Value: Returns an integer status code. The numeric value **0** indicates successful completion.
See *Status Codes* on page 121 for error code description.

Input Parameters: `int probeHandle`

Output Parameters: **Int battery:** The battery status as the percentage of full charge.

ETS_READTEMPERATURESYNCHRONOUS()

```
int ETS_ReadTemperatureSynchronous(int Handle, int  
&temperature);
```

Purpose: Reads the internal temperature of the probe and returns only after the probe has responded or a timeout has occurred.

Return Value: Returns an integer status code. The numeric value **0** indicates successful completion.
See *Status Codes* on page 121 for error code description.

Input Parameters: `int probeHandle`

Output Parameters: **Int temperature:** The probe internal temperature in degrees Celsius.

ETS_SERIALNUMBER()

```
int ETS_SerialNumber(const int probeHandle, char *serialNumber,  
const int arraySize);
```

Purpose: Returns the serial number of the probe.

Return Value: Returns an integer status code. The numeric value **0** indicates successful completion.
See *Status Codes* on page 121 for error code description.

Input Parameters: int probeHandle

Output Parameters: Pass-by-reference character string `serialNumber`:
Specify the length of string.

ETS_SETRANGE()

```
int ETS_SetRange(const int probeHandle, int range);
```

- Purpose:** Sets the range for the probe. The default value is **0**, which is in Auto Range. The number of ranges is probe-dependent.
- Return Value:** Returns an integer status code. The numeric value **0** indicates successful completion.
See *Status Codes* on page 121 for error code description.
- Input Parameters:** int probeHandle
Int range: Accepts values 0–5.
- Output Parameters:** None.

ETS_SETUNITS()

```
int ETS_SetUnits(const int probeHandle, int Unit);
```

- Purpose:** Switches the field units for the probe. The available units are probe-dependent. Consult the probe user manual for more information.
- Return Value:** Returns an integer status code. The numeric value **0** indicates successful completion.
See *Status Codes* on page 121 for error code description.
- Input Parameters:** int probeHandle
Int unit: Accepts values 1–3.
- Output Parameters:** None.

ETS_TEMPERATUREC()

```
int ETS_TemperatureC(const int probeHandle, int &TempC);
```

- Purpose:** Reads the internal temperature of the probe. **ETS_InitiateReadTemperature** must be called prior to this function call. Use the **ETS_IsOperationComplete** to check for operation completion.
- Return Value:** Returns an integer status code. The numeric value **0** indicates successful completion. See *Status Codes* on page 121 for error code description.
- Input Parameters:** `int probeHandle`
- Output Parameters:** Pass-by-reference integer that is the temperature of the probe in degrees Celsius.

ETS_LASERCURRENT()

```
int ETS_LaserCurrent(int Handle, float &current);
```

Purpose: Reads the laser current of the probe.
ETS_ReadBattery must be called to refresh this value.

Return Value: Returns an integer status code. The numeric value **0** indicates successful completion.
See *Status Codes* on page 121 for error code description.

Input Parameters: int probeHandle

Output Parameters: The laser current of the probe in amps.

ETS_VERSION()

```
int ETS_Version(char *version, const int arraySize);
```

Purpose:	Identifies the version of ETSProbe DLL.
Return Value:	Returns an integer status code. The numeric value 0 indicates successful completion. See <i>Status Codes</i> on page 121 for error code description.
Input Parameters:	None.
Output Parameters:	A character string that represents the version of ETSProbe DLL.

ETS_SUPPLYVOLTAGE()

```
int ETS_SupplyVoltage(int Handle, float &voltage);
```

Purpose: Monitors the converter voltage of the laser. In addition the battery voltage of the probe is accessible through this function. **ETS_ReadBattery** function must be called to refresh this value.

Return Value: Returns an integer status code. The numeric value **0** indicates successful completion.
See *Status Codes* on page 121 for error code description.

Input Parameters: `int probeHandle`

Output Parameters: The converter voltage or battery voltage.

ETS_LASERTEMPERATURE()

```
int ETS_LaserTemperature(int Handle, float &degreesC);
```

- Purpose:** Monitors the laser temperature.
ETS_ReadTemperature must be called to refresh this value.
- Return Value:** Returns an integer status code. The numeric value **0** indicates successful completion.
See *Status Codes* on page 121 for error code description.
- Input Parameters:** int probeHandle
- Output Parameters:** Outputs the temperature of the laser in degrees Celsius.

ETS_ZEROPROBE()

```
int ETS_ZeroProbe(int Handle);
```

Purpose: Zeros older style probes; has no effect on the HI-6000 Series probes.

Return Value: Returns an integer status code. The numeric value **0** indicates successful completion.
See *Status Codes* on page 121 for error code description.

Input Parameters: int probeHandle

Output Parameters: None.

Status Codes

A description of the status code can be returned by calling the function **ETS_GetErrorDescription**. See *Advanced Function Reference* on page 124 for the description of the function call.

Codes	Description
0	OK
1	Probe handle does not exist
2	Probe family does exist
3	Unable to open communication port
4	Probe not connected
5	Probe response incorrect
6	Operation timeout
7	Busy
8	Probe object does not exist
9	Probe did not respond
10	Probe out of range
11	Invalid input parameter
12	Probes internal gain setting incorrect (cycle power)
13	Error in closing the COMM port
14	Unable to purge COMM port
15	COMM port error
16	Error in writing to COMM port
17	Error in reading from COMM port
18	Laser current too high

Codes	Description
19	Internal thread error
20	Bad connection string
21	Value cannot be set
22	Probe model not supported
23	Unable to open file
24	Coefficients do not match
25	Coefficients file error
26	Probe over range
27	Probe under range
28	Function not available
29	Battery fail
30	Battery warning
31	Correction not loaded
32	Out of correction range
33	Correction not supported

This page intentionally left blank.

Appendix F: EC Declaration of Conformity

The EC Declaration of Conformity is the method by which ETS-Lindgren, L.P. declares that the equipment listed on this document complies with the EMC Directive and Low Voltage Directive.

<u>Factory</u>	<u>Issued by</u>
ETS-Lindgren, L.P. 1301 Arrow Point Drive Cedar Park, TX, USA 78613	ETS-Lindgren, L.P. 1301 Arrow Point Drive Cedar Park, TX, USA 78613

The products listed below are eligible to bear the CE mark:

- **HI-6122 Electric Field Probe**
- **HI-6153 Electric Field Probe**
- **HI-6105 Electric Field Probe**
- **HI-6022 Electric Field Probe**
- **HI-6053 Field Probe**
- **HI-6005 / FP6001 Field Probe**
- **HI-4422 / FP5000 Field Probe**

APPLICABLE REQUIREMENTS

<u>Standard</u>	<u>Criteria</u>
EN 50082-1	– Electromagnetic compatibility – General immunity standard – Part 1: Domestic commercial and light-industrial environment
EN 55011	– CISPR 11 (1990) ed.2 – Threshold values and measuring methods for radio interference by HF equipment for industrial scientific and medical purposes
EN 61010-1	Safety requirements for electrical equipment for measurement, control and laboratory use

AUTHORIZED SIGNATORIES

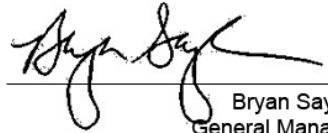

Bryan Saylor,
General Manager

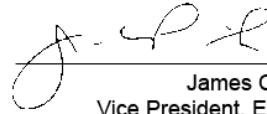

James C. Psencik,
Vice President, Engineering



Charles Garrison,
Quality Assurance

The authorizing signatures on the EC Declaration of Conformity document authorize ETS-Lindgren, L.P. to affix the CE mark to the indicated product. CE marks placed on these products will be distinct and visible. Other marks or inscriptions liable to be confused with the CE mark will not be affixed to these products. ETS-Lindgren, L.P. has ensured that appropriate documentation shall remain available on premises for inspection and validation purposes for a period of no less than 10 years.