

FLUKE®

Biomedical

INCU™ II

Incubator Analyzer

Users Manual

PN FBC-0091

October 2015, Rev.1

© 2015 Fluke Corporation. All rights reserved. Specifications are subject to change without notice.

All product names are trademarks of their respective companies.

Warranty and Product Support

Fluke Biomedical warrants this instrument against defects in materials and workmanship for one year from the date of original purchase OR two years if at the end of your first year you send the instrument to a Fluke Biomedical service center for calibration. You will be charged our customary fee for such calibration. During the warranty period, we will repair or at our option replace, at no charge, a product that proves to be defective, provided you return the product, shipping prepaid, to Fluke Biomedical. This warranty covers the original purchaser only and is not transferable. The warranty does not apply if the product has been damaged by accident or misuse or has been serviced or modified by anyone other than an authorized Fluke Biomedical service facility. NO OTHER WARRANTIES, SUCH AS FITNESS FOR A PARTICULAR PURPOSE, ARE EXPRESSED OR IMPLIED. FLUKE SHALL NOT BE LIABLE FOR ANY SPECIAL, INDIRECT, INCIDENTAL OR CONSEQUENTIAL DAMAGES OR LOSSES, INCLUDING LOSS OF DATA, ARISING FROM ANY CAUSE OR THEORY.

This warranty covers only serialized products and their accessory items that bear a distinct serial number tag. Recalibration of instruments is not covered under the warranty.

This warranty gives you specific legal rights and you may also have other rights that vary in different jurisdictions. Since some jurisdictions do not allow the exclusion or limitation of an implied warranty or of incidental or consequential damages, this limitation of liability may not apply to you. If any provision of this warranty is held invalid or unenforceable by a court or other decision-maker of competent jurisdiction, such holding will not affect the validity or enforceability of any other provision.

Notices

All Rights Reserved

© Copyright 2015, Fluke Biomedical. No part of this publication may be reproduced, transmitted, transcribed, stored in a retrieval system, or translated into any language without the written permission of Fluke Biomedical.

Copyright Release

Fluke Biomedical agrees to a limited copyright release that allows you to reproduce manuals and other printed materials for use in service training programs and other technical publications. If you would like other reproductions or distributions, submit a written request to Fluke Biomedical.

Unpacking and Inspection

Follow standard receiving practices upon receipt of the instrument. Check the shipping carton for damage. If damage is found, stop unpacking the instrument. Notify the carrier and ask for an agent to be present while the instrument is unpacked. There are no special unpacking instructions, but be careful not to damage the instrument when unpacking it. Inspect the instrument for physical damage such as bent or broken parts, dents, or scratches.

Technical Support

For application support or answers to technical questions, either email techservices@flukebiomedical.com or call 1-800- 850-4608 or 1-440-248-9300. In Europe, email techsupport.emea@flukebiomedical.com or call +31-40-2965314.

Claims

Our routine method of shipment is via common carrier, FOB origin. Upon delivery, if physical damage is found, retain all packing materials in their original condition and contact the carrier immediately to file a claim. If the instrument is delivered in good physical condition but does not operate within specifications, or if there are any other problems not caused by shipping damage, please contact Fluke Biomedical or your local sales representative.

Returns and Repairs

Return Procedure

All items being returned (including all warranty-claim shipments) must be sent freight-prepaid to our factory location. When you return an instrument to Fluke Biomedical, we recommend using United Parcel Service, Federal Express, or Air Parcel Post. We also recommend that you insure your shipment for its actual replacement cost. Fluke Biomedical will not be responsible for lost shipments or instruments that are received in damaged condition due to improper packaging or handling.

Use the original carton and packaging material for shipment. If they are not available, we recommend the following guide for repackaging:

- Use a double-walled carton of sufficient strength for the weight being shipped.
- Use heavy paper or cardboard to protect all instrument surfaces. Use nonabrasive material around all projecting parts.
- Use at least four inches of tightly packed, industry-approved, shock-absorbent material around the instrument.

Returns for partial refund/credit:

Every product returned for refund/credit must be accompanied by a Return Material Authorization (RMA) number, obtained from our Order Entry Group at 1-440-498-2560.

Repair and calibration:

To find the nearest service center, go to www.flukebiomedical.com/service or

In the U.S.A and Asia.:

Cleveland Calibration Lab

Tel: 1-800-850-4608 x2564

Email: globalcal@flukebiomedical.com

In Europe, Middle East, and Africa:

Eindhoven Calibration Lab

Tel: +31-40-2675300

Email: ServiceDesk@fluke.com

To ensure the accuracy of the Product is maintained at a high level, Fluke Biomedical recommends the product be calibrated at least once every 12 months. Calibration must be done by qualified personnel. Contact your local Fluke Biomedical representative for calibration.

Certification

This instrument was thoroughly tested and inspected. It was found to meet Fluke Biomedical's manufacturing specifications when it was shipped from the factory. Calibration measurements are traceable to the International System of Units (SI) through recognized national measurement institutes, radiometric techniques, or natural physical constants.

WARNING

Unauthorized user modifications or application beyond the published specifications may result in electrical shock hazards or improper operation. Fluke Biomedical will not be responsible for any injuries sustained due to unauthorized equipment modifications.

Restrictions and Liabilities

Information in this document is subject to change and does not represent a commitment by Fluke Biomedical. Changes made to the information in this document will be incorporated in new editions of the publication. No responsibility is assumed by Fluke Biomedical for the use or reliability of software or equipment that is not supplied by Fluke Biomedical, or by its affiliated dealers.

Manufacturing Location

The INCU II is manufactured for Fluke Biomedical, 6920 Seaway Blvd., Everett, WA, U.S.A.

Table of Contents

| Title | Page |
|--|------|
| Introduction | 1 |
| Intended Use | 1 |
| Safety Information | 2 |
| Symbols | 3 |
| Glossary | 4 |
| Unpack the Analyzer | 6 |
| Analyzer Familiarization | 8 |
| Analyzer Controls | 10 |
| Setup the Analyzer | 12 |
| Turn on the Analyzer | 12 |
| Select a Menu Item | 12 |
| Set the Language on the Analyzer | 12 |
| Use the Analyzer Keyboard | 12 |
| Setup Menu | 13 |
| Setup Communications | 14 |

| | |
|---|----|
| Analyzer Operation | 16 |
| Placement Pad..... | 16 |
| Pretest Check | 19 |
| Clear Memory | 19 |
| Test Preparation | 19 |
| STC..... | 20 |
| Probe Connections | 22 |
| Save a Test..... | 25 |
| View Saved Tests | 25 |
| Delete Tests..... | 26 |
| Save Tests to a PC | 26 |
| Excel Add-in..... | 26 |
| Menus..... | 27 |
| General Test | 27 |
| Individual Test..... | 28 |
| Test Groups | 28 |
| Create Test Groups..... | 28 |
| View and Start a Test Group | 29 |
| Test List by Standard..... | 30 |
| Test List by Test Order | 34 |
| Test Procedures | 37 |
| Warm-up Time | 37 |
| Inside — Sound Level | 38 |
| Inside — Alarm Level..... | 39 |
| Outside — Alarm Level | 40 |
| Air Flow Velocity Threshold | 41 |
| Infant Contact Surface Temperature..... | 42 |
| Skin Temperature Sensor Accuracy | 43 |
| Temperature Distribution Accuracy..... | 43 |

| | |
|---|----|
| Operating Temperature Accuracy..... | 45 |
| Uniformity of Temperature..... | 46 |
| Stability of Incubator Temperature..... | 47 |
| Accuracy of Indicator..... | 49 |
| RH Accuracy..... | 50 |
| Overshoot for Incubator Temperature..... | 51 |
| Temperature Control Accuracy..... | 52 |
| Overshoot of Temperature for Open Door..... | 53 |
| Operating on Battery Power..... | 54 |
| Change in Ambient Temperature..... | 55 |
| Maintenance and Troubleshooting..... | 56 |
| Clean the Analyzer..... | 57 |
| Set the Calibration Factors..... | 57 |
| Troubleshooting..... | 58 |
| Radio Frequency Certification..... | 58 |
| Replaceable Parts and Accessories..... | 59 |
| Specifications..... | 61 |
| Environmental Specifications..... | 61 |
| Measurements and Test Specifications..... | 62 |

List of Tables

| Table | Title | Page |
|--------------|---|-------------|
| 1. | Symbols..... | 3 |
| 2. | Glossary | 4 |
| 3. | Front-Panel Controls | 10 |
| 4. | Softkeys for the Keyboard | 12 |
| 5. | Setup Menu Options..... | 13 |
| 6. | Wireless Settings..... | 15 |
| 7. | Probe Connections | 22 |
| 8. | Save Test Fields..... | 25 |
| 9. | Individual and General Test Actions | 28 |
| 10. | Test Group Actions..... | 29 |
| 11. | List of Tests by Standard | 30 |
| 12. | Baby Incubator Tests | 34 |
| 13. | Transport Incubator Tests | 35 |
| 14. | Radiant Warmer Tests | 36 |
| 15. | Troubleshooting..... | 58 |
| 16. | Replaceable Parts | 59 |
| 17. | Accessories | 60 |

List of Figures

| Figure | Title | Page |
|---------------|---|-------------|
| 1. | Items included with the Analyzer | 7 |
| 2. | Connections | 9 |
| 3. | Front-Panel Controls | 11 |
| 4. | Analyzer Placement | 16 |
| 5. | Center the Probes on each Mattress Quadrant | 17 |
| 6. | Analyzer and Puck Placement..... | 18 |
| 7. | Temperature Probe connections | 21 |
| 8. | Test Setup with Probes | 24 |

Introduction

The INCU II (the Analyzer or the Product) is a portable incubator analyzer that verifies the operation and environment of baby incubators, transport incubators, and radiant warmers. The Analyzer verifies the parameters that are important to the care of infants over time. These parameters include: temperature, airflow, sound, and humidity. The Analyzer has a rechargeable battery and can stay in the incubator chamber up to 24 hours without compromise to the integrity of the environment.

Intended Use

The intended use for the analyzer is to test in compliance with standards, perform preventative maintenance, repair verification, and routine verification of baby incubators and radiant warmers.

The intended user is a trained biomedical equipment technician who performs periodic preventative maintenance checks on baby incubators and radiant warmers in service. Users can be associated with hospitals, clinics, original equipment manufacturers and independent service companies that repair and service medical equipment. The end user is an individual, trained in medical instrumentation technology. This Product is intended to be used in the laboratory environment, outside of the patient care area, and is not intended for use on patients, or to test devices while connected to patients. This Product is not intended to be used to calibrate medical equipment. It is intended for over the counter use. Designed around AAMI and IEC standards that specify incubator and radiant warmer sound levels, airflow, and thermal characteristics, the INCU II simultaneously measures airflow, relative humidity, sound, and five independent temperatures.

Safety Information

A **Warning** identifies conditions and procedures that are dangerous to the user. A **Caution** identifies conditions and procedures that can cause damage to the Product or the equipment under test.

⚠⚠ Warning











To prevent possible electrical shock, fire, or personal injury:

- Read all safety information before you use the Product.
- Carefully read all instructions.
- Use the Product only as specified, or the protection supplied by the Product can be compromised.
- Do not touch voltages > 30 V ac rms, 42 V ac peak, or 60 V dc.
- Do not use the Product around explosive gas, vapor, or in damp or wet environments.
- Do not use the Product if it operates incorrectly.
- Use this Product indoors only.
- Use only the mains power cord and connector approved for the voltage and plug configuration in your country and rated for the Product.
- Replace the mains power cord if the insulation is damaged or if the insulation shows signs of wear.
- Use only the external mains power supply included with the Product.
- Use only current probes, test leads, and adapters supplied with the Product.
- Use only products accessories listed as standard or optional in this manual. Use only accessories approved by Fluke Biomedical.
- Disable the Product if it is damaged.
- Do not use the Product if it is damaged.
- Do not use a two-conductor mains power cord unless you install a protective ground wire to the Product ground terminal before you operate the Product.
- Do not put metal objects into connectors.
- Do not use an extension cord or adapter plug.

Symbols

Table 1 is a list of symbols used on the Analyzer and in this manual.

Table 1. Symbols

| Symbol | Description | Symbol | Description |
|---|--|---|--|
|  | WARNING. RISK OF DANGER. |  | Consult user documentation. |
|  | WARNING. HAZARDOUS VOLTAGE. Risk of electric shock. |  | This product contains a lithium-ion battery. |
|  | Conforms to relevant Australian EMC standards. |  | Conforms to European Union directives. |
|  | Conforms to relevant South Korean EMC Standards. |  | Certified by CSA Group to North American safety standards. |
|  | Complies with 47 CFR Part 15 requirements of the U.S. Federal Communications Commission. | | |
|  | This product complies with the WEEE Directive marking requirements. The affixed label indicates that you must not discard this electrical/electronic product in domestic household waste. Product Category: With reference to the equipment types in the WEEE Directive Annex I, this product is classed as category 9 "Monitoring and Control Instrumentation" product. Do not dispose of this product as unsorted municipal waste. | | |

Glossary

Table 2 is a list of terms used in this manual.

Table 2. Glossary

| Term | Definition |
|------------------------------------|---|
| DUT (Device Under Test) | The baby incubator, transport incubator, or radiant warmer that the Analyzer is measuring or that you are preparing for measurement. |
| STC (Steady Temperature Condition) | When the temperature of the DUT does not vary by more than 1 °C for one hour. |
| Infant | A patient that is under three months of age and that weighs less than 10 kg (22 lb). |
| Sensor | A device that measures specific characteristics of the environment such as sound, humidity, airflow, and temperature. On the Analyzer these are also called probes or pucks. |
| Probe | A device that measures specific characteristics of the environment. Temperature probes make temperature measurements in a baby incubator or transport incubator. |
| Puck (Temperature puck) | A device used to make temperature measurements in a radiant warmer. Temperature pucks are aluminum discs each with a mass of 500 g \pm 10 g and a diameter of 100 mm \pm 2 mm and contain a high accuracy temperature sensor. |

Table 2. Glossary (cont.)

| Term | Definition |
|-----------------------|---|
| Normal condition | The DUT has all protections against hazards in place and the protections are operating. Unless otherwise specified, all tests in this manual assume the DUT is operating in normal condition. |
| Air-controlled | The DUT automatically keeps the air temperature constant by using an air temperature probe to make temperature measurements. Use the control on the DUT to set the temperature. |
| Baby-controlled | The DUT automatically keeps the temperature constant by using a skin temperature probe to make temperature measurements. Use the control on the DUT to set the temperature. |
| Average temperature | The average of the temperature measurements that are taken at regular intervals during STC. |
| Incubator temperature | The temperature of the air 10 cm above the center of the mattress in the compartment of the DUT. |

Unpack the Analyzer

Carefully unpack all items from the box and check that you have the following items (See Figure 1):

- ① INCU II
- ② Air Flow Probe
- ③ Humidity Probe
- ④ Sound Probe
- ⑤ Temperature Probes (5 connector types: red, yellow, white, blue, and green)
- ⑥ Temperature Pucks (5 connector types: red, yellow, white, blue, and green)
- ⑦ Placement Pad
- ⑧ 4 Tripods
- ⑨ USB Cable (Type A to Micro B)
- ⑩ K-Type Thermocouple
- ⑪ Power Adapter
- ⑫ Carrying Case

Included, but not pictured:

- Getting Started Manual
- Users Manual CD
- Skin Temperature Heater Assembly (optional)
- Carrying Case (pucks)

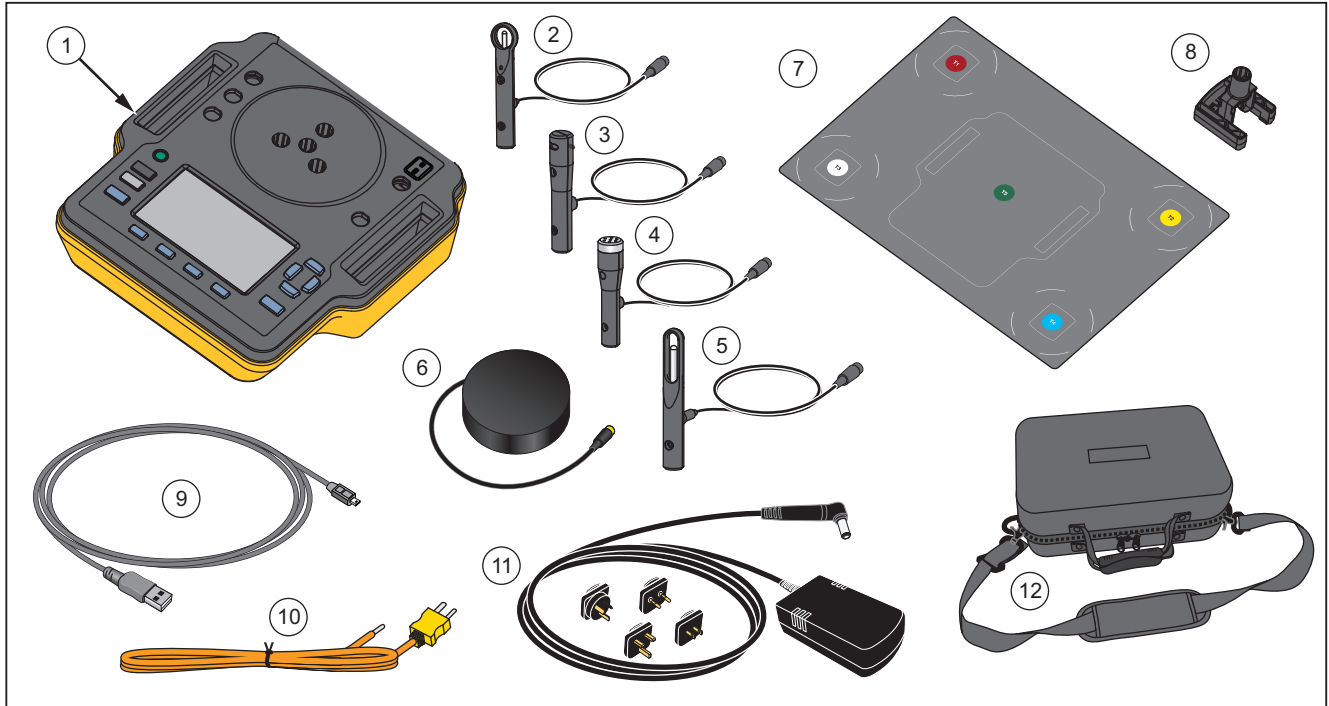

Figure 1. Items included with the Analyzer

hxy008.eps

Analyzer Familiarization

Figure 2 shows these connections on the top and back of the Analyzer:

- ① Temperature sensor connections (T1 through T4)
- ② Temperature sensor connection (T5)
- ③ Temperature probe connection for K-Type Thermocouple
- ④ Power connection
- ⑤ Sound probe connection
- ⑥ Humidity probe connection
- ⑦ Airflow probe connection
- ⑧ Skin Temperature connection
- ⑨ USB port
- ⑩ Tripod spacers

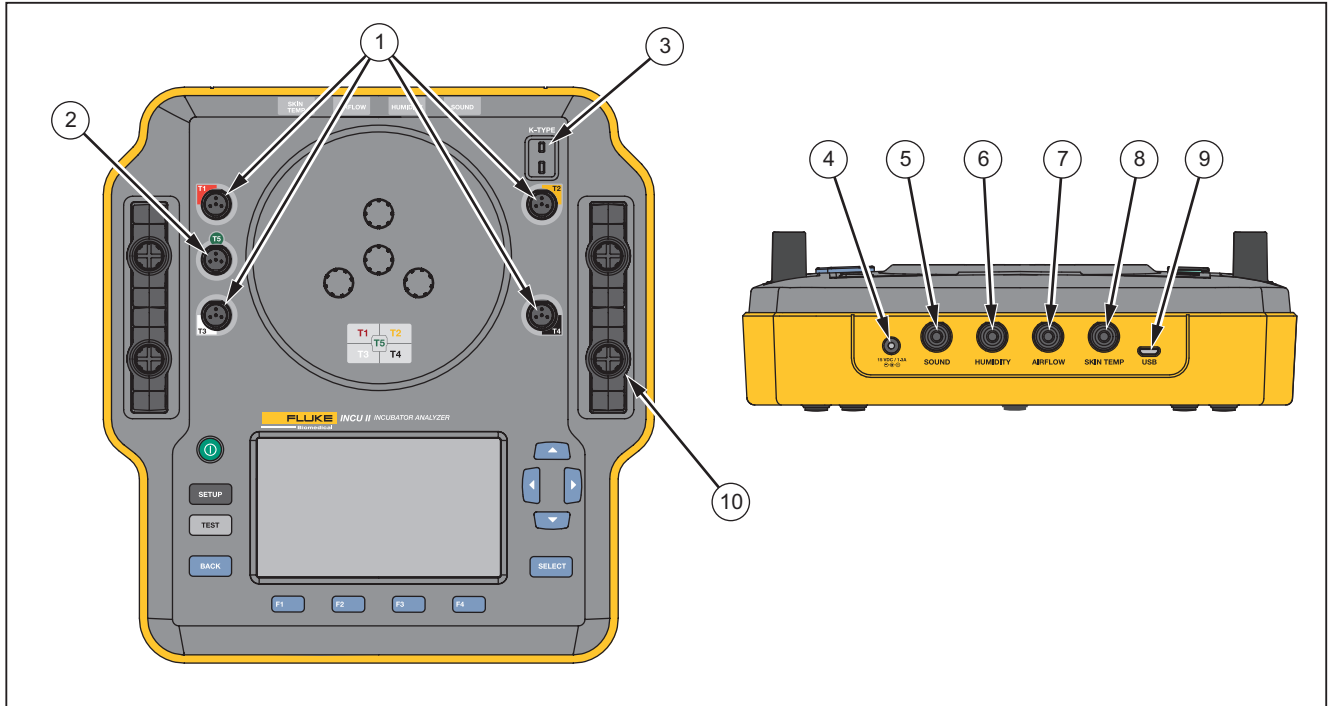















Figure 2. Connections

hxy001.eps

Analyzer Controls

Table 3 and Figure 3 identify the controls on the Analyzer.

Table 3. Front-Panel Controls

| Item | Description | |
|------|--|--|
| ① |  | On/Off power switch. |
| ② |  | Access the Setup menu. |
| ③ |  | Start the test. |
| ④ |  | Go back to the previous screen. |
| ⑤ |     | Softkeys that select the function shown on the screen. |
| ⑥ |     | Directional arrow keys used to position the cursor. |
| ⑦ |  | Select the highlighted text. |
| ⑧ | -- | Display |

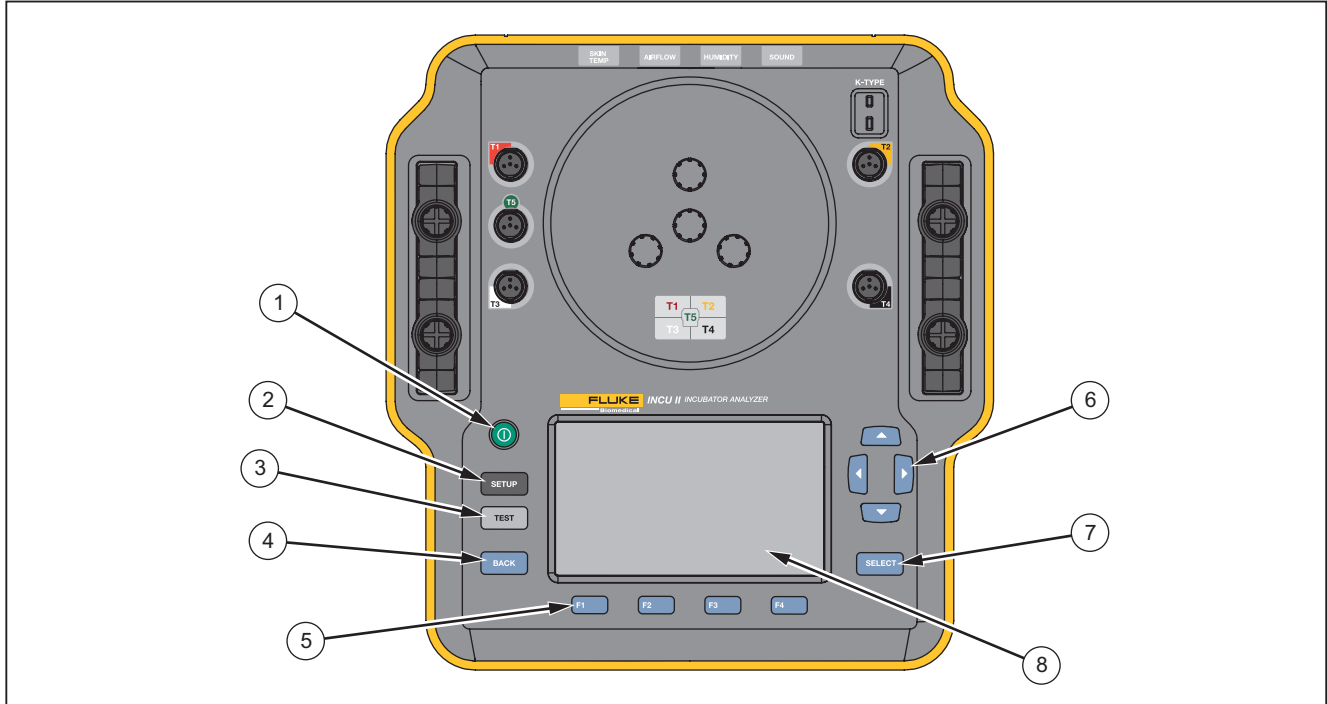

Figure 3. Front-Panel Controls

hxy002.eps

Setup the Analyzer

Turn on the Analyzer



Before you turn on the Analyzer, check all cables and connections for damage or wear. Replace any damaged components before use.

To turn on the Analyzer, push .

The Analyzer does a self-check. When the Analyzer is ready for operation, the Main menu shows on the display.





Select a Menu Item

To make a selection:

1. Use  and  to highlight the menu item.
2. Push .

Set the Language on the Analyzer

To set the language:

1. Push .
2. Use  and  to highlight **Language** and then push .
3. Highlight the language to use and then push .

Use the Analyzer Keyboard

Some options open a keyboard to enter text or numbers. To use a keyboard on the Analyzer:









1. Use , , and  to move the highlight.
2. Push  to accept the entry.
3. Use the softkeys to edit the entry. Table 4 shows the options.

Table 4. Softkeys for the Keyboard

| Softkey | Name | Description |
|---|------------------|--|
|  | Cancel | Discards the entry and returns to the previous screen. |
|  | Clear | Deletes the entire entry. |
|  | Backspace | Deletes one letter backward. |
|  | Done | Saves the entry and returns to the previous screen. |

Setup Menu

Use the Setup menu to set user preferences. Table 5 shows the available options.

To access the Setup menu, push **SETUP**.

Note

Some settings affect the battery life. For example, Brightness, Auto Dim, and Wireless.

Table 5. Setup Menu Options

| Option | Description |
|------------------------|---|
| Technician List | Edit the list of technicians. The list of technicians shows when you save test results. |
| Date | Enter the date or change the date format. |
| Time | Enter the time or change the time format. |
| Brightness | Set the brightness level for the display. |

Table 5. Setup Menu Options (cont.)

| Option | Description |
|-------------------------------|---|
| Auto Dim | Select a duration. The screen dims if there is no activity for the selected duration. Select Disabled to turn off the feature. |
| Language | Choose a display language. |
| Instrument Information | Show the Analyzer serial number, version, and verification date. |
| Probe Information | Shows a list of probes. Select a probe to see calibration factors. |
| Units | Set the units for airflow and temperature. |
| Wireless Enabled | Wireless Analyzers: Turn on or off wireless. Non-wireless Analyzers: shows Disabled . |
| Wireless Configuration | Enter a wireless key to make the unit capable of wireless. Contact Fluke Biomedical for details. |

Table 5. Setup Menu Options (cont.)

| Option | Description |
|----------------------------------|---|
| Temperature Sampling Rate | For single and group tests: select how often the Analyzer will measure and record the temperature. (For General tests, see <i>General Test</i> .) |
| Heater Assembly | Select whether or not the optional Skin Temperature Heater Assembly is available. |

Setup Communications

The Analyzer has a USB Device Port for communication to a computer (PC). Some Analyzers also have wireless functionality. Use the communications ports to:

- Send saved test records to a PC.

Operating system requirements:

- Windows Vista
- Windows 7
- Windows 8 or later

For Analyzers with wireless functionality, the wireless port communicates with a PC that has an 802.15.1 wireless interface. For PCs without the interface, use a commercially available USB adapter. The PC starts the interface when you connect the adapter. (Additional software is not necessary.)

The PC sees the wireless port while the Analyzer is on. When the Analyzer is turned off, the PC closes the port. When the wireless device is assigned to a COM port, the COM port reopens when the Analyzer is turned on.

Note

The wireless port on the Analyzer is a Classic 802.15.1 port not a Low Energy 802.15.1 port.

To install a wireless device:

1. Right-click the Bluetooth Devices icon and select **Add a Device**, or select **Show Bluetooth Devices | Add a Device**.

The Analyzer shows in the window. The serial number of the Analyzer is part of the name.

Note

It is okay if the icon shows as a headset, or with the name, Bluetooth headset. These are defaults. The name will change to the Analyzer.

2. Select the Analyzer and click **Next**.

The system prompts you to compare the codes. Ignore the message and continue with the next step.

3. Make sure **Yes** is selected and click **Next**.

4. Select **Driver Software Installation**.

The system installs two COM ports. Ignore the message that the peripheral device failed, and close the window. The Add a Device window shows the device successfully added to the computer.

5. Close the Add a Device window.

6. Right-click the wireless icon and select **Show Bluetooth Devices**.

The Analyzer name (including serial number) shows. Ignore the message about the missing driver for the peripheral device.

7. Right-click the Analyzer and select **Properties**.

The Hardware section shows a COM port.

The Bluetooth Settings COM ports section shows two COM ports. The system uses the Outgoing port only.

Wireless Settings—For Analyzers with wireless functionality, Table 6 shows the settings. You do not need to change the default settings. Choose a method to open the settings:

- Right-click the wireless icon and select **Open Settings**.

- Right-click **Bluetooth** from the Start menu.
- If you installed an adapter, select **Control Panel | Devices and Printers**, then right-click the adapter and select **Bluetooth Settings**.

Table 6. Wireless Settings

| Option | Recommended Setting |
|--|--|
| Allow Bluetooth devices to connect to this computer. | Selected (Required) |
| Alert me when a new Bluetooth device wants to connect. | Selected |
| Show the Bluetooth icon in the notification area. | Selected |
| Allow Bluetooth devices to find this computer. | Not selected (The PC uses the Outgoing COM port to find the Analyzer.) |

Analyzer Operation

Placement Pad

Some tests use measurements from the center of each mattress quadrant. Determine the center of each quadrant for accuracy and repeatability. Use the placement pad to make sure the Analyzer and the sensors are in the correct and repeatable positions.

1. Align the placement pad on the center of the mattress. (See Figure 4.)
2. Find the center for each quadrant of the mattress. (See Figure 5.)
3. Put a probe (on a tripod) or puck in the center of each quadrant. (Puck placement is shown in Figure 6.)

Note

Mattresses can have different dimensions. Put the placement pad in the center of the mattress and measure to find the center of each quadrant. Typically, the center of each mattress quadrant is within the circles on the placement pad. You can make a mark on the placement pad for different mattress dimensions. Use the mark to make sure the sensors are in the same position each time you do the test.

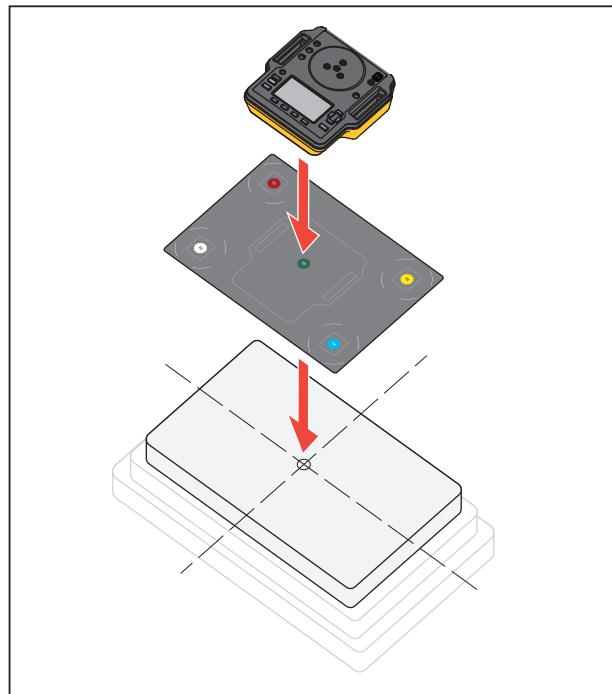

hxy007.eps

Figure 4. Analyzer Placement

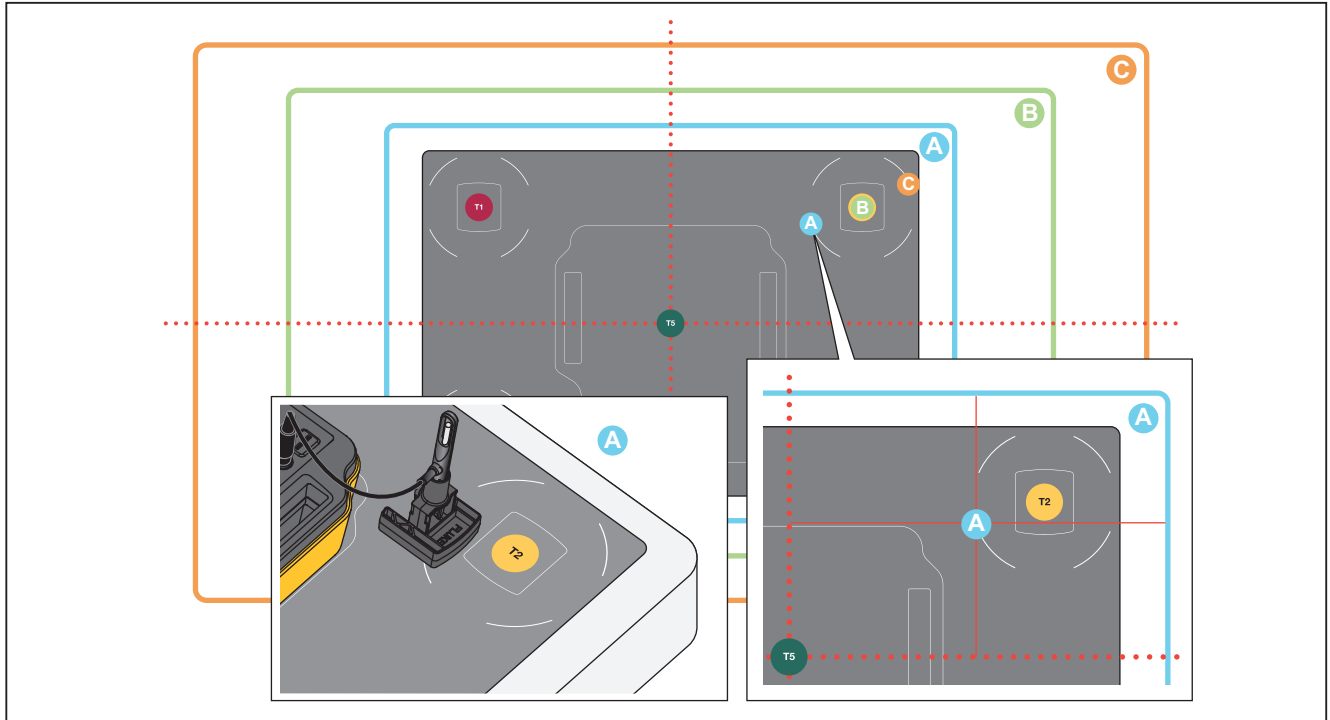

hxy012.eps

Figure 5. Center the Probes on each Mattress Quadrant

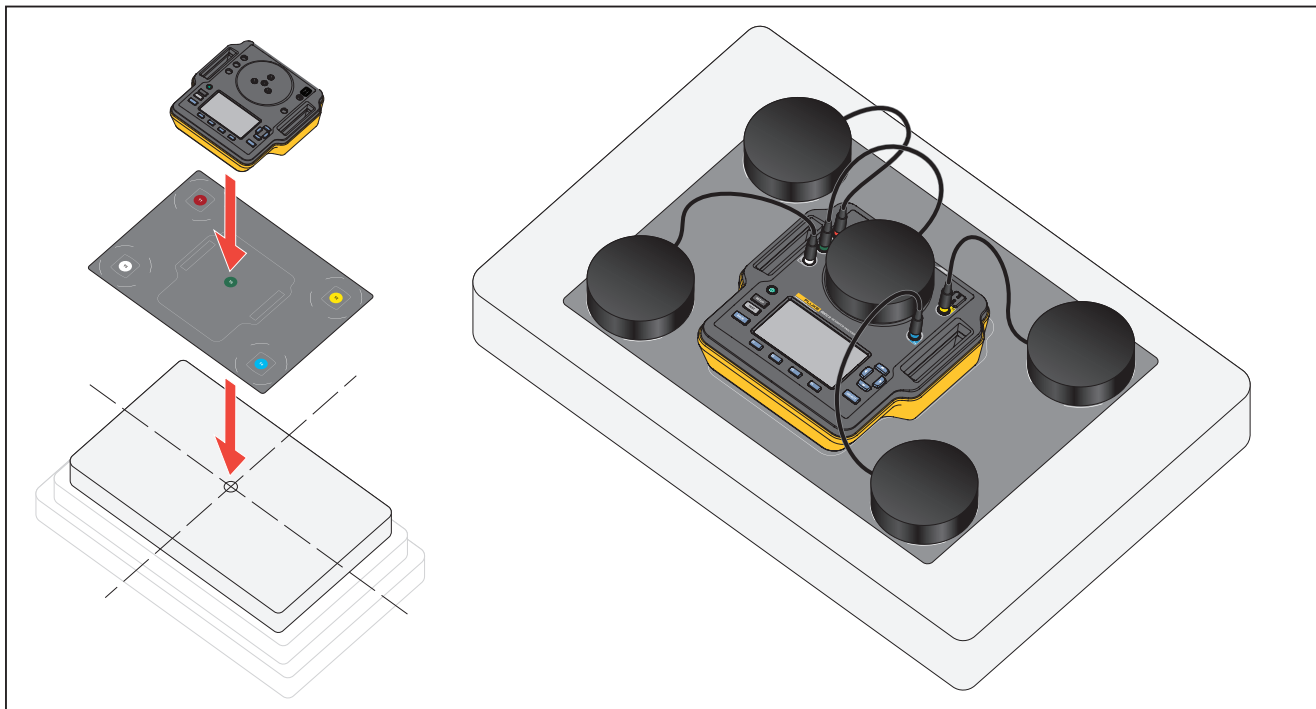

hxy010.eps

Figure 6. Analyzer and Puck Placement

Pretest Check

Before beginning a test, check the battery life and the available memory:

1. Push **SETUP**.
2. Use **▲** and **▼** to highlight **Instrument Information** and then push **SELECT**.

The display shows the percentage of available battery life and the percentage of available memory.

Clear Memory

When the memory is 80 % full the Analyzer indicates the percentage of memory in use. To clear the memory:

1. Push **SETUP**.
2. Use **▲** and **▼** to highlight **Instrument Information** and then push **SELECT**.
3. To clear the memory, push **F2** (**Clear Memory**) and then push **SELECT**.

Test Preparation

The Analyzer can test baby incubators, transport incubators, and radiant warmers. Each DUT has a standard that governs the device compliance. See Table 11 for a list of standards.

Before you begin any test:

- Make sure you can support the requirements for each test. Some tests require a change in ambient temperatures or a probe in a specific location.
- Make sure there is enough memory to store the complete set of measurements for the test. Higher sampling rates will require more memory.
- Make sure the battery is fully charged before beginning tests that use battery life. See *Pretest Check*. Tests that require additional time after STC or that have a higher sampling rate use more battery. To prevent potential data loss, Fluke Biomedical recommends that you plug the Analyzer into power for longer tests.
- Unless directed, set the DUT for normal operation.

- Connect the probes or pucks before you start the test. The Analyzer shows the results only from the sensors that are connected before the start of the test. For an example of test setup see Figure 8.
- Make sure that the Analyzer uses the correct calibration factors for temperature tests. Always use probes for an incubator or transport incubator. Always use pucks for a radiant warmer.
- Each sensor has a unique set of calibration factors. If you replace a probe or puck, you must enter the new calibration factors before you use the sensor. The Analyzer requires the correct calibration factors for measurement accuracy.
- To make sure the Analyzer uses the correct calibration factors, always connect the temperature probes or pucks to the correct color-coded jack. See Figure 7.
- For tests that have the Test Time option **Run Continuously (runs until stopped)**, the test must run for the minimum test time to get a valid result.
- Some tests require specific actions after the DUT gets to STC. To make sure the test results are valid for the standard, you must complete all the steps in the procedure within the Test Time.

STC

STC is a steady temperature condition for at least one hour. When the Analyzer calculates that the DUT has reached STC, the Analyzer records the time on the results screen.

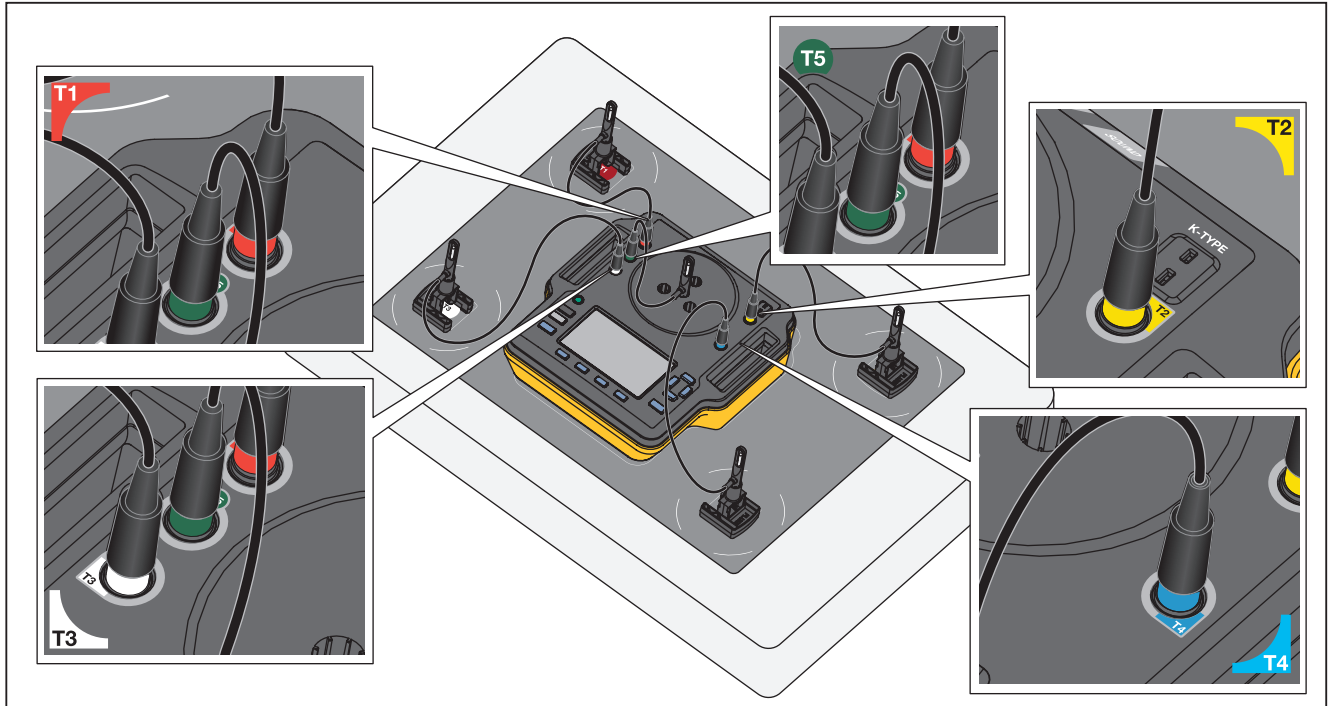

hxy009.eps

Figure 7. Temperature Probe connections

Probe Connections

Table 7 shows how the probes connect to the Analyzer. Figure 8 shows a test set up with all the probes connected.

Table 7. Probe Connections







| Probe Type | Connection |
|--|---|
| <p>Temperature Probe</p>  |  <p style="text-align: right; font-size: small;">hxy003.eps</p> |
| <p>Sound Probe</p>  |  <p style="text-align: right; font-size: small;">hxy005.eps</p> |

Table 7. Probe Connections (cont.)

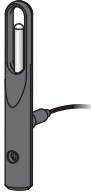
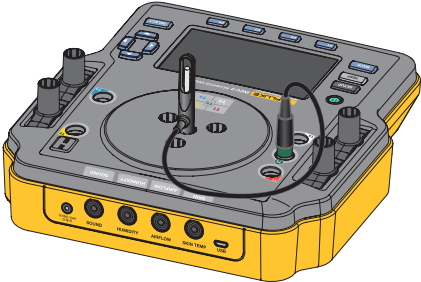
| Probe Type | Connection |
|---|--|
| <p data-bbox="161 254 328 279">Humidity Probe</p>  |  <p data-bbox="1394 552 1469 565">hxy004.eps</p> |
| <p data-bbox="161 582 320 607">Air Flow Probe</p>  |  <p data-bbox="1394 901 1469 915">hxy006.eps</p> |

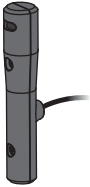
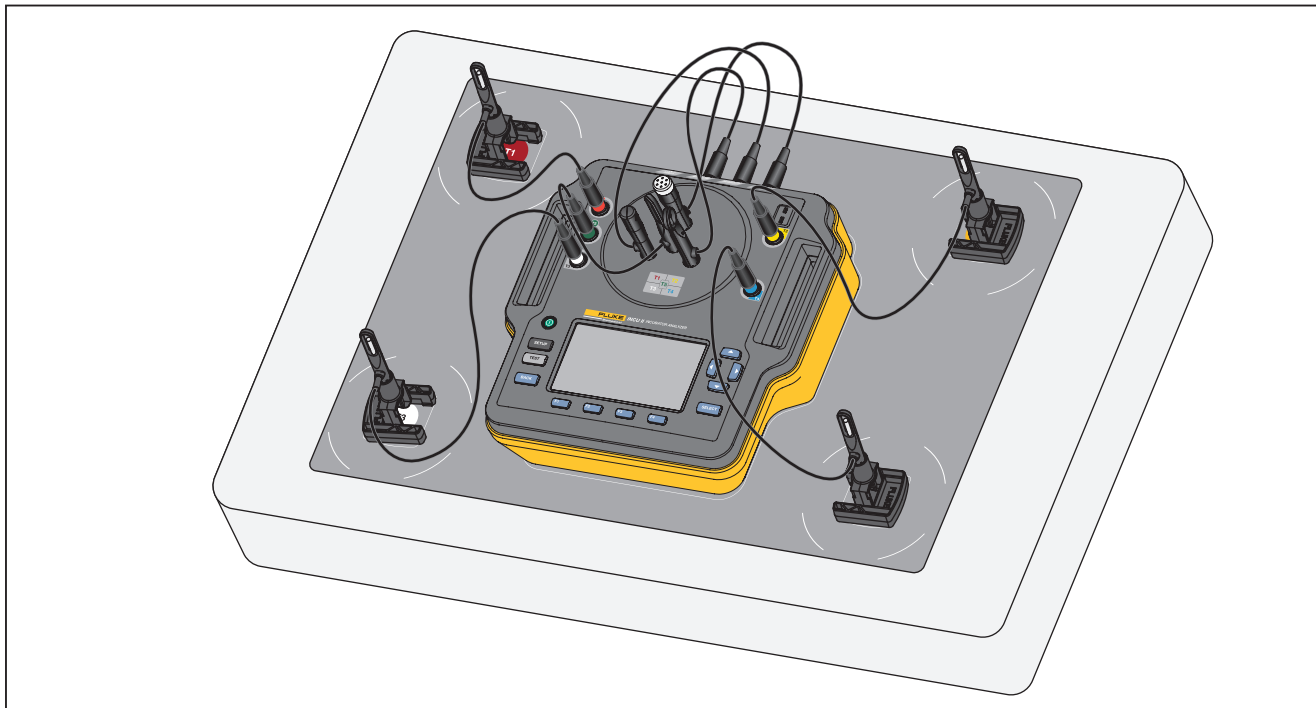

Figure 8. Test Setup with Probes

hxy011

Save a Test

You can save the results from an individual test or save all the results for a test group. The Analyzer prompts you for information. See Table 8.

To save an individual or general test, push **F3** (**Save**).

To save and exit a test group, wait until the group is complete or push **F4** (**Stop**) to stop the test. On the Overview screen, push **F3** (**Save**). The Analyzer stops the test group and saves the results.

View Saved Tests

To view saved tests from the Main menu:

1. Push **F4** (**View Saved Data**).
 - **Individual test** – use **▲** and **▼** to highlight a test and push **SELECT** to see the Results screen.
 - **Test Group** – use **▲** and **▼** to highlight the group and push **SELECT** to see the Overview screen. Highlight the test and push **SELECT** to see the Results screen.
2. From the Results screen you can:
 - Toggle between Details and Results, push **F4**.
 - Return to the test group Overview screen, push **F1** (**Pass/Fail**).
 - Delete a test, push **F1** (**Delete**) then highlight **OK** and push **SELECT**.

Table 8. Save Test Fields

| Field | Description |
|-------------------------|--|
| Test Environment | The type of device where the test was done. For a test group, you can select the type of DUT. |
| Technician | The name of the technician that did the test. Select from the list or add a new technician name. |
| Incubator ID | The identification for the DUT. Use the alphanumeric keyboard on the Analyzer to enter the ID. |
| Location | The location of the DUT. Use the alphanumeric keyboard on the Analyzer to enter the location. |

Delete Tests

You can delete tests from the Main menu. Push **F4** (**View Saved Data**). From the Saved Data screen you can:

- Delete all the tests: push **F3** (**Delete All**) then highlight **OK** and push **SELECT**.
- Delete an individual test:
 - a. Use **▲** and **▼** to highlight the test or test group.
 - b. Push **F2** (**Delete**) then highlight **OK** and push **SELECT**.

Save Tests to a PC

You can use a PC to transfer and view completed data from the Analyzer. Install the Ansur mini plug-in and the custom Excel add-in spreadsheet. Both are available on the CD or from www.flukebiomedical.com.

1. Use the provided USB cable to connect the Analyzer to the PC.
2. On the PC, open the plug-in to transfer the files.

Excel Add-in

Use the Excel Add-in on a PC to view results data. The Excel Add-in has these worksheets:

- **Configuration** – opens files from the PC and sets the default views.
- **View_Result** – shows a summary of the data in **Results Mode** (tabular test data) or **View Mode** (graphical format).
- **Data** – shows the raw data

Menus

From the Main menu, you can select a test environment, take a general test, or view saved tests.

General Test

Use the General Test to take readings from any sensor that is connected to the Analyzer. To do a General test:

1. Push **F1** (**General Test**).
2. Use **▲** and **▼** to highlight the type of temperature sensor you have connected and push **SELECT**.

⚠ Caution

Make sure to select the correct type of sensor. The wrong type of sensor will give inaccurate readings.

3. To select the sampling rate:
 - a. Push **F3** (**Sample Rate**).
 - b. Highlight the sample rate to change and push **SELECT**.
 - c. Highlight the new sample rate and push **SELECT**.
 - d. When you have set the sample rates, push **F4** (**Done**).

4. Push **TEST**.





The Analyzer takes measurements from each of the attached sensors and shows the results on the display.

Note

Airflow measurements require time for the environment to stabilize. For more accurate air flow measurements, allow readings to stabilize for ten minutes.



Individual Test

To take an individual test:

1. Use  and  to highlight the test environment and push .
2. Highlight the test and push .

See the *Test Procedures* section or follow the instructions on the Analyzer for more information about how to do the test. Table 9 describes the available actions during a test.

Table 9. Individual and General Test Actions

| Softkey | Action | Description |
|--|-----------------------|---|
|  | Cancel | Stop the current test and discard the data. |
|  | Save | Save the tests results for all the tests in the test group and exit the test. |
|  | Stop or Resume | Stop data collection or resume a stopped test. |





Test Groups

Use the test group feature to create a list of tests that execute in a sequence.

You can schedule a single test to execute multiple times to accommodate different specifications. For example the same test can measure at 32 °C and another instance can measure at 36 °C.

Create Test Groups

To create a test group:

1. Use  and  to highlight the test environment and push .
2. Push  (**Create Test Group**).

The Analyzer shows the list of available tests. Tests that have sub-modes are indicated with a black arrow when the text is highlighted.

3. Select the test to add the test to the group.

If a test has different sub-modes, the Analyzer shows a list of the available modes.

- a. Select the combination of modes for this test group.
- b. Highlight **Done** and push .

4. If you can define the duration of the test, the Select Test Time screen shows. Highlight the duration and push **SELECT** then highlight **Done** and push **SELECT**.
5. To remove a test from a group, highlight the test and push **SELECT**.
6. When you are finished, push **F4** (**Done**).
7. Use the keyboard to enter a name for the test group. See *Use the Analyzer Keyboard*.

View and Start a Test Group

To view or start a test group:

1. Select the test environment.
2. Push **F3** (**View Test Group**).
The Analyzer shows the list of test groups.
3. To view the tests in the test group, highlight the test group and push **SELECT**.
4. To view the test details, select the test. Use **F2** (**Sensor Placement**) and **F3** (**Test Summary**) for information on how to set up the test.
5. To start the test group sequence, push **TEST**.
The display shows the test status. Table 10 describes the available actions during a test.

Table 10. Test Group Actions

| Softkey | Action | Description |
|-----------|-----------------------|---|
| F1 | Pass/Fail | Pause the test and return to the overview screen. |
| F2 | Skip | Skip the test. The Analyzer prompts you to confirm. |
| F4 | Stop or Resume | Stop the test or resume a test that is stopped. |

Test List by Standard

Table 11 is a list of tests by standard.

Table 11. List of Tests by Standard

| Baby Incubator 60601-2-19 | Transport Incubator 60601-2-20 | Radiant Warmer 60601-2-21 | Test Description |
|--------------------------------------|---|--------------------------------------|---|
| -- | 201.4.10.102 | -- | Operating on Battery Power Make sure the Transport Incubator can maintain the temperature on battery power for at least 30 minutes. |
| 201.9.6.2.1.101 | 201.9.6.2.1.101 | -- | Inside — Sound Level Measure the level of sound in the compartment. |
| 201.9.6.2.1.102 | 201.9.6.2.1.102 | 201.9.6.2.1.101 | Outside — Alarm Level Measure the level of the audible alarm outside of the compartment. |
| 201.9.6.2.1.103 | 201.9.6.2.1.103 | 201.9.6.2.1.101 | Inside — Alarm Level Measure the level of the audible alarm in the compartment. |
| 201.11.1.2.2 | -- | -- | Infant Contact Surface Temperature Measure the temperature of each surface that the infant might touch. |

Table 11. List of Tests by Standard (cont.)

| Baby Incubator 60601-2-19 | Transport Incubator 60601-2-20 | Radiant Warmer 60601-2-21 | Test Description |
|--------------------------------------|---|--------------------------------------|--|
| 201.12.1.101 | 201.12.1.101 | -- | Stability of Incubator Temperature (32 °C and 36 °C) Make sure the temperature stays at the setting. |
| 201.12.1.102 | 201.12.1.102 | -- | Uniformity of Temperature (32 °C and 36 °C) Make sure that the temperature is the same throughout the compartment. |
| 201.12.1.103 | 201.12.1.103 | 201.12.1.101 | Skin Temperature Sensor Accuracy Measure the skin temperature sensor with calibrated heater assembly. |
| | | 201.12.1.102 | Temperature Distribution Accuracy Make sure that the average temperature of the mid-point is the same as the average of the other test points. |
| -- | -- | 201.12.1.103 | Operating Temperature Accuracy Make sure that the temperature control is the actual temperature sensed by the skin temperature probe. |

Table 11. List of Tests by Standard (cont.)

| Baby Incubator 60601-2-19 | Transport Incubator 60601-2-20 | Radiant Warmer 60601-2-21 | Test Description |
|------------------------------|---|------------------------------|--|
| 201.12.1.105 | 201.12.1.105 | -- | Accuracy of Indicator (32 °C and 36 °C) Check the accuracy of the temperature indicated by the incubator. |
| 201.12.1.106 | 201.12.1.106 (Ambient 15 °C and 25 °C) | -- | Temperature Control Accuracy (32 °C) Make sure the temperature control sets the temperature to the correct value. |
| 201.12.1.107 | 201.12.1.107 | -- | Warm-up Time Check that the incubator gets to the temperature in the time specified in the manual for the incubator. |
| 201.12.1.108 | 201.12.1.108 | -- | Overshoot for Incubator Temperature Make sure the incubator does not get too hot when warming up. |
| 201.12.1.109 | 201.12.1.109 | -- | RH Accuracy Check the accuracy of the relative humidity. |

Table 11. List of Tests by Standard (cont.)

| Baby Incubator 60601-2-19 | Transport Incubator 60601-2-20 | Radiant Warmer 60601-2-21 | Test Description |
|--------------------------------------|---|--------------------------------------|---|
| 201.12.1.111 | 201.12.1.111 | -- | Air Flow Velocity Threshold Measure the airflow in the compartment. |
| -- | 201.12.1.113 | -- | Change in Ambient Temperature Make sure the transport incubator maintains the temperature when the ambient temperature changes. |
| -- | 201.12.1.115 | -- | Overshoot of Temperature for Open Door Make sure the transport incubator does not get too hot when it warms back up after the door is opened. |

Test List by Test Order

The Analyzer completes the tests in a set order to minimize the changes to the incubator temperature. Table 12 is a list of the Baby Incubator tests (60601-2-19), Table 13 is a list of the Transport Incubator tests (60601-2-20), and Table 14 is a list of Radiant Warmer tests (60601-2-21).

Table 12. Baby Incubator Tests

| Order | 60601-2-19 Section | Description | See page |
|--------------|---------------------------|---|-----------------|
| 1 | 201.12.1.107 | Warm-up Time | 37 |
| 2 | 201.9.6.2.1.101 | Inside — Sound Level | 38 |
| 3 | 201.9.6.2.1.103 | Inside — Alarm Level | 39 |
| 4 | 201.9.6.2.1.102 | Outside — Alarm Level | 40 |
| 5 | 201.12.1.111 | Air Flow Velocity Threshold | 41 |
| 6 | 201.11.1.2.2 | Infant Contact Surface Temperature | 42 |
| 7 | 201.12.1.103 | Skin Temperature Sensor Accuracy | 43 |
| 8 | 201.12.1.102 | Uniformity of Temperature (For tests at 32 °C) | 46 |
| 9 | 201.12.1.101 | Stability of Incubator Temperature (For tests at 32 °C) | 47 |
| 10 | 201.12.1.105 | Accuracy of Indicator (32 °C and 36 °C) | 48 |
| 11 | 201.12.1.109 | RH Accuracy | 50 |
| 12 | 201.12.1.108 | Overshoot for Incubator Temperature | 50 |

Table 12. Baby Incubator Tests (cont.)

| Order | 60601-2-19 Section | Description | See page |
|--------------|---------------------------|---|-----------------|
| 13 | 201.12.1.102 | Uniformity of Temperature (For tests at 36 °C) | 46 |
| 14 | 201.12.1.101 | Stability of Incubator Temperature (For tests at 36 °C) | 47 |
| 15 | 201.12.1.106 | Temperature Control Accuracy | 51 |

Table 13. Transport Incubator Tests

| Order | 60601-2-20 Section | Description | See page |
|--------------|---------------------------|--|-----------------|
| 1 | 201.12.1.107 | Warm-up Time | 37 |
| 2 | 201.9.6.2.1.101 | Inside — Sound Level | 38 |
| 3 | 201.9.6.2.1.103 | Inside — Alarm Level | 39 |
| 4 | 201.9.6.2.1.102 | Outside — Alarm Level | 40 |
| 5 | 201.12.1.111 | Air Flow Velocity Threshold | 41 |
| 6 | 201.12.1.103 | Skin Temperature Sensor Accuracy | 43 |
| 7 | 201.12.1.102 | Uniformity of Temperature (For tests at 32 °C) | 46 |
| 8 | 201.12.1.101 | Stability of Incubator Temperature (32 °C) | 47 |
| 9 | 201.12.1.105 | Accuracy of Indicator (For tests at 32 °C) | 48 |
| 10 | 201.12.1.109 | RH Accuracy | 50 |

Table 13. Transport Incubator Tests (cont.)

| Order | 60601-2-20 Section | Description | See page |
|--------------|---------------------------|---|-----------------|
| 11 | 201.12.1.108 | Overshoot for Incubator Temperature | 50 |
| 12 | 201.12.1.102 | Uniformity of Temperature (For tests at 36 °C) | 46 |
| 13 | 201.12.1.101 | Stability of Incubator Temperature (For tests at 36 °C) | 47 |
| 14 | 201.12.1.102 | Temperature Control Accuracy (32 °C and 36 °C) | 51 |
| 15 | 201.12.1.105 | Accuracy of Indicator (For tests at 36 °C) | 48 |
| 16 | 201.12.1.115 | Overshoot of Temperature for Open Door | 52 |
| 17 | 201.4.10.102 | Operating on Battery Power | 54 |
| 18 | 201.12.1.113 | Change in Ambient Temperature | 54 |

Table 14. Radiant Warmer Tests

| Order | 60601-2-21 Section | Description | See page |
|--------------|---------------------------|-----------------------------------|-----------------|
| 1 | 201.9.6.2.1.101 | Outside — Alarm Level | 40 |
| 2 | 201.9.6.2.1.101 | Inside — Alarm Level | 39 |
| 3 | 201.12.1.101 | Skin Temperature Sensor Accuracy | 43 |
| 4 | 201.12.1.102 | Temperature Distribution Accuracy | 43 |
| 5 | 201.12.1.103 | Operating Temperature Accuracy | 44 |

Test Procedures

The Analyzer completes the tests in a set order to minimize the changes to the incubator temperature. See the *Test List by Test Order* section for a list of all tests in the order they are executed.

Warm-up Time

201.12.1.107 (Baby Incubator)

201.12.1.107 (Transport Incubator)

Use this test to make sure the warm-up time stated in the DUT manual is accurate.

Pass Criteria

To pass, the temperature must increase by 11 °C in $\pm 20\%$ of time given in the DUT manual.

Prepare for the Test

To get accurate test results:

- Start with the DUT off and at ambient temperature.
- Set the DUT to air-controlled operation.
- Make sure the water level is normal and the water is also at ambient temperature.

Procedure

1. Turn off the DUT.
2. Make sure the DUT and the water tank are at ambient temperature.
3. On the Analyzer:
 - a. Select the test environment.
 - b. Select **Warm-up Time**.
 - c. Push **SELECT** and enter the warm-up time given in the user documentation of the DUT. When you are finished push **F4** (**Done**).
 - d. Connect the T5 probe to the Analyzer and put the probe in the center of the Analyzer. (See Figure 8.)
 - e. Put the Analyzer at the center of the mattress.
 - f. Push **TEST**.

The Analyzer measures the ambient temperature and prompts you to set the DUT to the appropriate temperature.

4. Turn on the DUT and:
 - a. Set the temperature control to the temperature indicated by the Analyzer.
 - b. Set the humidity control to maximum humidity.
5. On the Analyzer, push **TEST**.

Note

*For best results, minimize the time between turning on the DUT and pushing **TEST**.*

6. Close the compartment.

The Analyzer measures the time it takes to reach the given temperature and then shows the results.

Inside — Sound Level

201.9.6.2.1.101 (Baby Incubator)

201.9.6.2.1.101 (Transport Incubator)

This test checks the sound level inside of the compartment.

Pass Criteria

To pass, the sound in the compartment must be ≤ 60 dBA. The background sound must also be ≤ 10 dBA of the measured sound.

Prepare for the Test

To get accurate test results:

- Put the DUT in quiet ambient environment in a reflective room.
- Start with the alarms turned off.

Procedure

1. Turn off the DUT.
2. On the Analyzer:
 - a. Select the test environment.
 - b. Select **Inside—Sound Level**.
 - c. Connect the sound probe to the Analyzer and put the probe in the center of the Analyzer. (See Table 7.)
 - d. Put the Analyzer at the center of the mattress.
 - e. Push **TEST**.
3. On the DUT:
 - a. Close the compartment.

Wait for the Analyzer to measure the background sound level. The Analyzer prompts you to continue the test.

- b. Turn on the DUT. The DUT should be in normal operation.
- c. Set the controls to 36 °C and maximum humidity.
4. On the Analyzer, push **SELECT** to continue. The Analyzer starts a countdown to the measurement.
5. Close the compartment and wait for the Analyzer to do the test.

The Analyzer takes the measurement after the delay time and then shows the results.

Inside — Alarm Level

201.9.6.2.1.103 (Baby Incubator)

201.9.6.2.1.103 (Transport Incubator)

201.9.6.2.1.101 (Radiant Warmer)

This test measures the level of the audible alarm inside of the compartment.

Pass Criteria

To pass, the alarm sound must be ≥ 10 dBA above background sound and the alarm sound is ≤ 80 dBA.

Prepare for the Test

To get accurate test results:

- Put the DUT in quiet ambient environment in a reflective room.
- Start with the alarms turned off.

Note

The 201.9.6.2.1.101 (Audible alarms sound level) test in IEC 60601-2-21 measures sound from a height of 5 cm above the mattress. On the Analyzer, the height of the probe is 10 cm above the mattress. Fluke Biomedical finds no difference in sound levels between 5 cm and 10 cm and considers the heights equivalent for this test.

Procedure

For each selectable alarm frequency:

1. On the Analyzer:
 - a. Select the test environment.
 - b. Select **Inside— Alarm Level**.
 - c. Connect the sound probe to the Analyzer and put the probe in the center of the Analyzer. (See Table 7.)

- d. Put the Analyzer at the center of the mattress.
 - e. Push **TEST**.
Wait for the Analyzer to measure the background sound level. When the background measurement is complete, the Analyzer prompts you to turn on the alarm.
 - f. Push **SELECT** to continue. The Analyzer starts a countdown to the measurement.
2. On the DUT:
 - a. Close the compartment, if necessary.
 - b. Set the controls to 36 °C and maximum humidity.
 - c. Activate the alarm. If alarm is adjustable it must be set to at least 50 dbA. The Analyzer takes the measurement.
 3. When the Analyzer shows the results, turn off the alarm.

Outside — Alarm Level

201.9.6.2.1.102 (Baby Incubator)

201.9.6.2.1.102 (Transport Incubator)

201.9.6.2.1.101 (Radiant Warmer)

This test measures the level of the audible alarm outside of the compartment.

Pass Criteria

To pass, the alarm sound must be ≥ 10 dBA above the background sound level and ≥ 65 dBA (for non-adjustable alarms) or ≥ 50 dBA (at the lowest adjustable setting).

Prepare for the Test

To get accurate test results:

- Put the DUT in quiet ambient environment in a reflective room.
- Repeat the test for each of the selectable frequencies.

Procedure

For each selectable alarm frequency:

1. Put the sound probe 1.5 m above the floor and 3 m in front of the DUT.
2. On the DUT, set the controls to 36 °C and maximum humidity.
3. On the Analyzer:
 - a. Select the test environment.
 - b. Select **Outside—Alarm Level**.
 - c. Put the Analyzer in the compartment.
 - d. Push **TEST**.
4. Close the compartment if necessary.

Wait for the Analyzer to measure the background sound level. When the background sound measurement is complete, the Analyzer prompts you to activate the incubator alarm.

5. On the Analyzer, push **SELECT** to continue.

6. On the DUT:
 - a. Close the compartment, if necessary.
 - b. Activate the alarm. If alarm is adjustable it must be set to at least 50 dbA.

The Analyzer takes the measurement.
7. When the Analyzer shows the results, turn off the Alarm.

Air Flow Velocity Threshold

201.12.1.111 (Baby Incubator)

201.12.1.111 (Transport Incubator)

This test measures the air velocity inside the compartment.

Pass Criteria

To pass, the velocity must be ≤ 0.35 m/s at each location that you measure.

Prepare for the Test

To get accurate test results:

- Make sure there is enough time for the Air Flow probe to stabilize at the ambient temperature.
- Make measurements from the center of the mattress and from the center of each quadrant. Use the placement pad for consistency.

Procedure

For the first measurement, put the probe in the center of the mattress. For the next measurement, put the probe in the center of the first quadrant. Continue taking measurements at the center of each quadrant, in a clockwise direction.

1. On the Analyzer:
 - a. Select the test environment.
 - b. Select **Air Velocity Threshold**.
 - c. Put the placement pad on the mattress.
 - d. Connect the Air Flow probe to the Analyzer and put the probe in the center of the Analyzer. (See Table 7.)
 - e. Put the Analyzer in the center of the mattress.
 - f. Push **TEST**.
2. On the DUT:
 - a. Close the compartment.
 - b. Set the controls to 36 °C and maximum humidity.

The Analyzer waits for the airflow to stabilize and then does the measurement. When the measurement is complete, the Analyzer prompts you to move the probe to the next location.

3. Put the probe on a tripod and put the tripod in the next location and then push **SELECT** to continue.
4. On the Analyzer, push **TEST**.
5. On the DUT, close the compartment.

When the test is done, the Analyzer shows the results.

Infant Contact Surface Temperature

201.11.1.2.2 (Baby Incubator)

This test checks all the surfaces that might touch the infant and makes sure the surfaces do not get too hot.

Pass Criteria

To pass, the applied parts must be ≤ 40 °C. The temperature of any metal that can touch the infant must be ≤ 40 °C. The temperature of all other surfaces that can touch the infant must be ≤ 43 °C.

Prepare for the Test

To get accurate test results:

- Use a thermal compound to ensure good contact between the surface and the thermocouple.
- Repeat the test for each surface that can touch the infant.

Procedure

1. On the DUT, set the controls to the maximum temperature.
2. On the Analyzer:
 - a. Select the test environment.
 - b. Select **Infant Contact Surface Temperature**.
 - c. Select how the surface touches the infant:
 - **Direct Contact** – for applied parts
 - **Accessible** – for surfaces that can touch the infant
 - d. Select the type of material to test:
 - **Metal**
 - **Other Material**
3. Attach the K-type thermocouple to the location with a thermal compound.
4. On the Analyzer, push and then close the compartment on the DUT.

The Analyzer starts the countdown clock and does the temperature measurement. When the test is done, the Analyzer shows the results.

Skin Temperature Sensor Accuracy

201.12.1.103 (Baby Incubator)

201.12.1.103 (Transport Incubator)

201.9.6.2.1.101 (Radiant Warmer)

Note

Requires the optional Skin Temperature Assembly.

For more information, see the instructions that come with the Skin Temperature Heater Assembly.

Temperature Distribution Accuracy

201.9.6.2.1.102 (Radiant Warmer)

This test compares the temperature of the mid-point to the temperature of other points in the warmer.

Pass Criteria

To pass, the average temperature of the mid-point temperatures must be within 2 °C of the other test points.

Prepare for the Test

To get accurate test results:

- Make sure the ambient temperature is 23.0 °C (±2.0).
- Make sure the air velocity is <0.1 m/s.

- If possible, set the DUT to baby-controlled.
- The test does not start until the DUT is at STC.

Note

The longer you wait to start the test after STC, the more stable the radiant warmer environment becomes. A more stable environment gives a more accurate reading. This is due to the radiant warmer environment and not the accuracy of the Analyzer.

Procedure

1. Put the DUT in a room where the ambient temperature is 23.0 °C (± 2.0).
2. On the Analyzer:
 - a. Select the test environment.
 - b. Select **Temperature Distribution Accuracy**.
 - c. To change the test time, push **F4** (**Test Time**) and select the time. The default test time is 60 minutes.
 - d. Put the placement pad on the mattress.

- e. Connect the pucks to the Analyzer.
 - f. Put the Analyzer in the center of the mattress.
 - g. Put the T5 puck at center of the Analyzer.
 - h. Put T1, T2, T3 and T4 pucks in the center of each quadrant. Use the placement pad as a guide.
 - i. Push **TEST**
3. On the DUT:
 - a. Close the compartment (if necessary).
 - b. Set the temperature to 36 °C.

The Analyzer takes measurements until the DUT reaches STC. This takes at least one hour. When the Analyzer detects STC, the Analyzer continues to measure for the test time.

When the test is done, the Analyzer shows the results.

Operating Temperature Accuracy

201.12.1.103 (Radiant Warmer)

This test compares the temperature control to the actual indication from the skin temperature probe.

Pass Criteria

To pass, the skin temperature probe and the temperature control must be within 0.5 °C.

Prepare for the Test

To get accurate test results:

- Make sure the ambient temperature is 23.0 °C (±2.0).
- Make sure the air velocity is less than 0.1 m/s.
- If possible, set the DUT to baby-controlled.
- The skin temperature sensor must make good thermal contact with the puck.

- Put the mattress in the horizontal position.
- The test does not start until the DUT is at STC.

Note

The longer you wait to start the test after STC, the more stable the radiant warmer environment becomes. A more stable environment gives a more accurate reading. This is due to the radiant warmer environment and not the accuracy of the Analyzer.

Procedure

1. Put the radiant warmer in a room with the ambient temperature is 23.0 °C (±2.0).
2. On the Analyzer:
 - a. Select the test environment.
 - b. Select **Operating Temperature Accuracy**.
 - c. To change the test time, push **F4** (**Test Time**) and select the time. The default test time is 60 minutes.

- d. Connect the skin temperature probes to the T5 puck.
 - e. Put the puck on the center of the Analyzer and put the Analyzer at the center of the mattress.
 - f. Push **TEST**.
3. On the DUT:
- a. Close the compartment (if necessary)
 - b. Set the temperature to 36 °C.

The Analyzer takes measurements until the DUT reaches STC. This takes at least one hour. When the Analyzer detects STC, the Analyzer continues to measure for the test time. The Analyzer prompts you to enter the temperature shown on the incubator.

4. On the Analyzer, use **↵** and **⏏** to enter the temperature and then select **Done**.

When the test is done, the Analyzer shows the results.

Uniformity of Temperature

201.12.1.102 (Baby Incubator)

201.12.1.102 (Transport Incubator)

This test makes sure the temperature is the same throughout the incubator.

Pass Criteria

Baby Incubator: To pass, the average temperature of each of the quadrants must be within 0.8 °C of the midpoint or within 1.0 °C if the mattress is tilted.

Transport Incubator: To pass, the average temperature of each of the quadrants must be within 1.5 °C of the midpoint or within 2.0 °C if the mattress is tilted.

Prepare for the Test

To get accurate test results:

- Repeat the test with the mattress in the horizontal position and at the extremes of the tilt angle.

Note

You can create a test group to repeat the test for each tilt angle. If you must open the incubator to change the tilt level, then the incubator must get to STC before the test.

- Set the DUT to air-controlled operation.
- The test does not start until the DUT is at STC.

Procedure

1. On the DUT, adjust the mattress to the horizontal position.
2. On the Analyzer:
 - a. Select the test environment.
 - b. Select **Uniformity of Temperature**.
 - c. To change the test time, push **F4** (**Test Time**) and select the time. The default test time is 30 minutes.
 - d. Select the test temperature as 32 °C or 36 °C.
 - e. Select the mattress tilt.
 - f. Put the placement pad on the mattress.
 - g. Connect the T5 probe to the Analyzer and put the probe in the center of the Analyzer. (See Figure 7.)
 - h. Put the Analyzer at the center of the mattress.
 - i. Connect the T1, T2, T3 and T4 probes to the Analyzer and put them in position on the placement pad.

3. Set the DUT to the test temperature.
4. On the Analyzer, push **TEST** and close the compartment on the DUT.

When the test is done, the Analyzer shows the results.

Stability of Incubator Temperature

201.12.1.102 (Baby Incubator)

201.12.1.102 (Transport Incubator)

This test makes sure that the incubator can stay at a consistent temperature for at least one hour.

Pass Criteria

Baby Incubator: The average temperature = any temperature reading ± 0.5 °C.

Transport Incubator: The average temperature = any temperature reading ± 1.0 °C.

Prepare for the Test

To get accurate test results:

- The test does not start until the DUT is at STC.
- Run the test at control temperatures of 32 °C and 36 °C.

Procedure

1. On the incubator, adjust the mattress to the horizontal position.
2. On the Analyzer:
 - a. Select the test environment.
 - b. Select **Stability of Incubator Temperature**.
 - c. To change the test time, push **F4** (**Test Time**) and select the time. The default test time is 60 minutes.
 - d. Connect the T5 probe to the Analyzer and put the probe in the center of the Analyzer. (See Figure 7.)
 - e. Put the Analyzer at the center of the mattress.
3. Set the DUT to the test temperature.

4. On the Analyzer, push **TEST**.

5. Close the DUT.

The Analyzer takes measurements to make sure the DUT reaches STC. This takes at least one hour. When the Analyzer detects STC, the Analyzer continues to measure for the test time.

6. Use **▲** and **▼** to enter the temperature and then select **Done**.

When the test is done, the Analyzer shows the results.

Accuracy of Indicator

201.12.1.105 (Baby Incubator)

201.12.1.105 (Transport Incubator)

This test makes sure the temperature indicated by the incubator is the actual incubator temperature.

Pass Criteria

Baby Incubator: The average temperature = the temperature indication ± 0.8 °C.

Transport Incubator: The average temperature = the temperature indication ± 1.5 °C.

Prepare for the Test



To get accurate test results:

- The test does not start until the DUT is at STC.
- For an accurate test you must calculate the average temperature of the indication shown on the DUT after the test starts.
- Run the test at control temperatures of 32 °C and 36 °C.

Procedure

1. On the Analyzer:
 - a. Select the test environment.
 - b. Select **Accuracy of Indicator**.
 - c. To change the test time, push **F4** (**Test Time**) and select the time. The default test time is 60 minutes.
 - d. Connect the T5 probe to the Analyzer and put the probe in the center of the Analyzer. (See Table 7.)
 - e. Put the Analyzer at the center of the mattress.
2. On the Analyzer, select the test temperature as 32 °C or 36 °C.
3. Set the incubator to the test temperature.
4. On the Analyzer, push **TEST**.
5. Close the DUT.

The Analyzer takes measurements to make sure the incubator reaches STC. This takes at least one hour.

6. Track the indication on the incubator display at regular intervals and calculate the average.
7. Use  and  to enter the average temperature you have calculated from the display temperature and then push .

When the test is done, the Analyzer shows the results.

RH Accuracy

201.12.1.109 (Baby Incubator)

201.12.1.109 (Transport Incubator)

This test checks the humidity level throughout the incubator.

Pass Criteria



Baby Incubator: The incubator value = tester value ± 10 %

Transport Incubator: The incubator value = tester value ± 15 %.

Procedure

1. On the Analyzer:
 - a. Select the test environment.
 - b. Select **RH Accuracy**.
2. Connect the humidity probe to the Analyzer and put the probe in the center of the Analyzer. (See Table 7.)
3. Put the Analyzer at the center of the mattress.
4. Set the incubator control between 32 °C and 36 °C.
5. On the Analyzer, push .
6. Close the DUT.

The Analyzer measures the humidity. The Analyzer prompts you to enter the humidity indication.

7. On the Analyzer, use  and  to enter the humidity indication on the incubator and then push .

When the test is done, the Analyzer shows the results.

Overshoot for Incubator Temperature

201.12.1.108 (Baby Incubator)

201.12.1.108 (Transport Incubator)

This test makes sure the temperature increases in time without going over 38 °C.

Pass Criteria

Baby Incubator: Make sure that when the temperature is increased from 32 °C to 36 °C the incubator stays ≤ 38 °C. In 15 minutes, the temperature must get to 36 °C and be stable enough to start the STC measurement.

Transport Incubator: Make sure that when the temperature is increased from 32 °C to 36 °C the incubator stays ≤ 38 °C.

Prepare for the Test

To get accurate test results:

- Set the DUT to air-controlled operation.
- The test does not start until the DUT is at STC.
- The test does not start unless the temperature reaches at least 36 °C.

Procedure

1. On the Analyzer:
 - a. Select the test environment.
 - b. Select **Overshoot of Incubator Temperature**.
2. Connect the T5 probe to the Analyzer and put the probe in the center of the Analyzer. (See Table 7.)
3. Put the Analyzer at the center of the mattress.
4. Close the compartment.
5. Set the DUT to the test temperature 32 °C.
6. On the Analyzer, push **TEST**.
7. Close the incubator.

The Analyzer takes measurements to make sure the DUT reaches STC. This takes at least one hour. When the Analyzer detects STC, the Analyzer prompts you to set the DUT temperature.

8. Set the incubator to 36 °C.

The test continues automatically when the DUT reaches 36 °C. The test continues until the DUT reaches STC. When the test is done, the Analyzer shows the results.

Temperature Control Accuracy

201.12.1.106 (Baby Incubator)

201.12.1.106 (Transport Incubator)

This test makes sure the temperature control setting sets an accurate temperature in the DUT. For a transport incubator, the test checks the accuracy at different ambient temperatures.

Pass Criteria

Baby Incubator: The incubator control setting = the tester measurement ± 1.5 °C.

Transport Incubator: To pass, the average temperature of each of the quadrants must be within 1.5 °C of the midpoint or within 2.0 °C if the mattress is tilted.

Prepare for the Test

To get accurate test results:

- The test does not start until the DUT is at STC.
- Set the DUT to air-controlled operation.
- For the transport incubator, do one test at an ambient temperature of 15 °C and one at an ambient temperature of 25 °C.

Procedure

1. For a transport incubator, put the DUT in a room where ambient temperature is controlled. Complete one test at 15 °C and one test at 25 °C.
2. On the Analyzer:
 - a. Select the test environment.
 - b. Select **Temperature Control Accuracy**.
 - c. For a transport incubator, select the ambient temperature.
 - d. To change the test time, push **F4** (**Test Time**) and select the time. The default test time is 30 minutes.
3. Connect the T5 probe to the Analyzer and put the probe in the center of the Analyzer. (See Figure 7.)
4. Put the Analyzer at the center of the mattress.
5. Set the DUT to the test temperature.
6. On the Analyzer, push **TEST**.
7. Close the DUT.

The Analyzer takes measurements to make sure the incubator reaches STC. This takes at least one hour.

When the test is done, the Analyzer shows the results.

Overshoot of Temperature for Open Door

201.12.1.115 (Transport Incubator)

This test makes sure the temperature increases in time without going over 38 °C.

Pass Criteria

Make sure that when the temperature is set to 36 °C the incubator stays ≤ 38 °C even if the DUT door opens for 10 minutes.

Prepare for the Test

To get accurate test results:

- Set the DUT to air-controlled operation.
- Do not open the door on the DUT until the DUT is at STC.
- After the door on the DUT is closed, let the test run long enough to determine whether overshoot occurs.

Procedure

1. On the Analyzer:
 - a. Select the test environment.
 - b. Select **Overshoot of Temperature for Open Door**.
 - c. To change the test time, push **F4** (**Test Time**) and select the time. The default test time is 30 minutes.
2. Connect the T5 probe to the Analyzer and put the probe in the center of the Analyzer. (See Figure 7.)
3. Put the Analyzer at the center of the mattress.
4. On the Analyzer, push **TEST**.
5. Close the compartment.
6. Set the DUT to the test temperature 36 °C.

The Analyzer takes measurements to ensure the incubator reaches STC. This takes at least one hour. When the Analyzer detects STC, the Analyzer prompts you to open the incubator access doors.
7. Open the DUT access doors.
8. After 10 minutes, select **OK** on the Analyzer and close the DUT access doors.

When the test is done, the Analyzer shows the results.

Operating on Battery Power

201.4.10.102 (Transport Incubator)

This test makes sure the temperature increases in time without going over 38 °C.

Pass Criteria

Transport Incubator: Make sure that when the temperature is increased from 32 °C to 36 °C the incubator stays ≤ 38 °C.

Prepare for the Test

To get accurate test results:

- Set the DUT to air-controlled operation.
- The test does not start until the DUT is at STC.
- Make sure the battery is fully charged at the start of the test.
- Connect all powered accessories to the DUT.
- You must operate the DUT on the transportable power supply for 90 minutes before the end of the test.

⚠ Caution

For valid test results, you must complete all the steps in the Test Time. Make sure to complete the action before the prompt on the Analyzer expires.

Procedure

1. Connect the DUT to Mains power.
2. On the Analyzer:
 - a. Select the test environment.
 - b. Select **Operation on Battery Power**.
 - c. To change the test time, push **F4** (**Test Time**) and select the time. The default test time is 90 minutes.
 - d. Connect the T5 probe to the Analyzer and put the probe in the center of the Analyzer. (See Table 7.)
3. Put the Analyzer at the center of the mattress.
4. On the Analyzer, push **TEST**.
5. Close the compartment.
6. On the DUT:
 - a. Turn on all powered accessories.
 - b. Set the DUT to the test temperature 36 °C.

The Analyzer takes measurements to ensure the incubator reaches STC. This takes at least one hour. When the Analyzer detects STC, the Analyzer prompts you to continue the test on battery power. The Analyzer measures for the test time.

7. When prompted, remove the DUT from Mains power. The incubator must remain on battery power for 90 minutes.

When the test is done, the Analyzer shows the results.

Change in Ambient Temperature

201.12.1.113 (Transport Incubator)

This test makes sure that the incubator temperature does not vary by more than 3 °C even if the ambient temperature changes.

Pass Criteria

Make sure that the incubator stays at 36 °C as it is moved from 25 °C to -5 °C.

Prepare for the Test

To get accurate test results:

- Fully charge the DUT battery prior to the test.
- Set the DUT to air-controlled operation.
- The test does not start until the DUT is at STC.
- The test requires a room with ambient temperature of -5 °C (± 2 °C) and the air velocity ≤ 1 m/s. (The DUT will be on battery power.)
- The test requires a room with ambient temperature of 21 °C to 25 °C and the air velocity ≤ 1 m/s. (The DUT is connected to Mains power.)

⚠ Caution

For valid test results, you must complete all the steps in the Test Time. Make sure monitor the status of STC.

Procedure

1. Put the DUT in a room with an ambient temperature between 20 °C and 25 °C.
2. On the Analyzer:
 - a. Select the test environment.
 - b. Select **Change in Ambient Temperature**.
 - c. To change the test time, push **F4** (**Test Time**) and select the time. The default test time is 60 minutes.
 - d. Connect the T5 probe to the Analyzer and put the probe in the center of the Analyzer.
 - e. Put the Analyzer at the center of the mattress
 - f. Push **TEST**.
3. Close the compartment.
4. Set the DUT to the test temperature 36 °C.

The Analyzer takes measurements to ensure the DUT reaches STC. This takes at least one hour.

The Analyzer measures for the test time.

5. After the DUT reaches STC, remove the DUT from Mains power.
6. Put the DUT in a room that is -5 °C (± 2 °C) for a minimum of 15 minutes.
7. After 15 minutes, put the DUT in a room with an ambient temperature between 20 °C and 25 °C.
8. Reconnect the DUT to Mains power.

When the test is done, the Analyzer shows the results.

Maintenance and Troubleshooting

⚠⚠ Warning

To prevent possible electrical shock, fire, or personal injury:

- **Repair the Product before use if the battery leaks.**
- **Be sure that the battery polarity is correct to prevent battery leakage.**
- **Use only Fluke approved power adapters to charge the battery.**
- **Batteries contain hazardous chemicals that can cause burns or explode. If exposure to chemicals occurs, clean with water and get medical aid.**
- **Do not disassemble the battery.**
- **Do not disassemble or crush battery cells and battery packs.**
- **Do not put battery cells and battery packs near heat or fire. Do not put in sunlight.**

- Do not short the battery terminals together.
- Do not keep cells or batteries in a container where the terminals can be shorted.
- Remove the input signals before you clean the Product.
- Use only specified replacement parts.
- Have an approved technician repair the Product.

⚠ Caution

Changes or modifications not expressly approved by Fluke could void the user's authority to operate the equipment.

Clean the Analyzer

The Analyzer needs little maintenance or special care. Treat the Analyzer and probes as calibrated measurement instruments. Avoid dropping or other mechanical abuse.

To clean the Analyzer, wipe with a damp cloth. Do not allow liquid to get into the Analyzer.

Wipe down the probes and cables with the same care.

Set the Calibration Factors

If you get a replacement probe or puck, you must set the calibration factors:

1. Push **SETUP**.
2. Use **▲** and **▼** to highlight **Instrument Information** and then push **SELECT**.
3. Highlight **Probe Information** and then push **SELECT**.
4. Highlight the sensor and then push **SELECT**.
5. Use the numeric keyboard to enter the calibration factor that came with the sensor. When you are finished push **F4** (**Done**).

Troubleshooting

Table 15 lists common problems and solutions.

Table 15. Troubleshooting

| Symptom | Resolution |
|--|--|
| The Analyzer does not show the Top Menu. | Connect the Analyzer to Power and make sure the battery is charged. |
| The Analyzer fails during the initial self-test. | Contact Fluke Biomedical Technical Support |
| The readings are inaccurate. | Make sure the probes are plugged into the correct plug. Make sure the probe calibration factors are correct. |

Radio Frequency Certification

For more information, go to www.flukebiomedical.com and search for Radio Frequency Data for Class A.

See *Setup Communications* for instructions on how to enable the radio.

Replaceable Parts and Accessories

Table 16 is a list of replaceable parts for the Analyzer.

Table 16. Replaceable Parts

| Item | Fluke Biomedical Part Number | |
|---|------------------------------|---------|
| Carrying Case | 4715749 | |
| Carrying Case (Pucks) | 4724692 | |
| Power Adapter – Universal Voltage, 100 V to 240 V with adapters | 4721194 | |
| USB Cable (Type A to Micro-B) 2m | 4721166 | |
| Placement Pad | 4715713 | |
| Tripod set of 4 | 4721109 | |
| INCU II Getting Started Manual | 4715708 | |
| INCU II Users Manual CD | 4715690 | |
| Radiant Warmer Pucks set of 5 | Red | 4721111 |
| | Yellow | 4721130 |
| | White | 4721148 |
| | Blue | 4721153 |
| | Green | 4721127 |

Table 16. Replaceable Parts (cont.)

| Item | | Fluke Biomedical Part Number | |
|--------|---------------------|------------------------------|---------|
| Probes | Temperature probes | Red (T1) | 4721039 |
| | | Yellow (T2) | 4721056 |
| | | White (T3) | 4721063 |
| | | Blue (T4) | 4721074 |
| | | Green (T5) | 4721042 |
| | Air Flow probe (1) | | 4721017 |
| | Sound probe (1) | | 4721000 |
| | Humidity Probe (1) | | 4721021 |
| | K-Type Thermocouple | | 4720996 |

Table 17 is a list of Analyzer Accessories.

Table 17. Accessories

| Item | Fluke Biomedical Part Number |
|-----------------------------|------------------------------|
| Skin Sensor Heater Assembly | 4721175 |

Specifications

Physical

- Size
(LxWxH-without sensors)... 23 cm x 21 cm x 6 cm (9.0 in x 8.5 in x 2.5 in)
- Total Weight 3.9 kg (8.5 lb)
 - With sensors only 1.4 kg (3 lb)
 - With Pucks (5)..... 2.5 kg (5.5 lb)
- Carrying case 1.1 kg (2.5 lb)

Power

- Power Adapter –
Universal voltage..... Input: 100 V to 240 V with adapters 50/60 Hz.
Output: 15 V dc, 1.3 A max.
- Rechargeable lithium-ion battery,
internal 7.4 V, 7800 Ah, 58 Wh
powers the unit for 24 hours with
sample rate set at 30 seconds

Interface

- Push navigation buttons..... Power On/Off, Test, Select, Back, and arrow keys
- User Preferences Adjust backlight, Display brightness, and Set clock
- View Verification history
- Recall and run templates on tester
- Recall past saved and stored tests results
- Templates time duration, frequency of data capture and tests.

- Select user preferences units of measure, view test results of current and past tests on the Analyzer
- View battery life indicator bar shows life remaining

Environmental Specifications

Temperature

- Operating temperature..... 10 °C to 40 °C
- Storage temperature -20 °C to 60 °C
- Humidity 10 % to 90 % non-condensing
- Altitude 2000 m
- Ingress Protection Rating... IP-20

Safety

IEC 61010-1:Overvoltage Category none, Pollution Degree 2

Electromagnetic Compatibility (EMC)

- IEC 61326-1: Basic
- Emissions Classification ... IEC CISPR11: Group 1, Class A.
Group 1 have intentionally generated and/or use conductively coupled radio-frequency energy which is necessary for the internal functioning of the equipment itself.
Class A equipment is suitable for use in nondomestic locations and/or directly connected to a low voltage power supply network.
- USA (FCC) Intentional Radiators
This device complies with part 15 of the FCC Rules. Operation is subject to the following two conditions: (1) This device may not cause harmful interference, and (2) this device must accept any interference received, including interference that may cause undesired operation.(15.19)

Korea (KCC)Class A Equipment (Industrial Broadcasting & Communication Equipment)
Class A: Equipment meets requirements for industrial electromagnetic wave equipment and the seller or user should take notice of it. This equipment is intended for use in business environments and not to be used in homes.

Wireless Module Listing

FCC (United States) compliant
 (Class A)FCC ID: X3ZBTMOD3
 IC (Industry Canada)
 compliantIC: 8828A-MOD3
 CE (European) certifiedCE0051
 802.15.1 qualifiedQD ID: B019224

Wireless Radio

Frequency range2412 to 2483 MHz
 Output Power10 mW

Measurements and Test Specifications

5 Air Convection Temperature for Incubator –
 Sensors in probes
 (T1-T5)0 °C to 50 °C
 Accuracy ± 0.05 °C
 Display Resolution0.01 °C

5 Air Convection Temperature for Radiant
 Warmers – Sensors in pucks
 (Black discs)0 °C to 50 °C
 Accuracy±0.2 °C
 Display Resolution0.01 °C
 Relative Humidity0 % to 100 %
 Accuracy±5 % RH (0 % to 10 % non-
 condensing)
 ±3 % RH (10 % to 90 %, non-
 condensing)
 ±5 % RH (90 % to 100 % non-
 condensing)
 Display Resolution0.1 % RH
 Air Flow0.2 m/sec to 2.0 m/sec at 35 °C,
 50 % RH
 Accuracy±0.1 m/sec
 Display Resolution0.01 m/sec
 Sound Pressure –
 (Class II)30 dB(A) to 100 dB(A)
 Accuracy±5 dB(A)
 Display Resolution0.1 dB(A)
 IEC-61672-1 Class 2 from 31.5 Hz to 8 kHz
 Surface temperature-5 °C to 60 °C
 Accuracy ±0.5 °C
 Display Resolution0.05 °C